



**Wireless Data
Connectivity for
Industrial
applications**

4G Wireless Industrial Router



**4G Wireless Router
User Manual**

Ver 1.4

Date Issued: 2021-09-30
King Pigeon Hi-Tech. Co., Ltd.

www.iot-solution.com

Provide data wireless access internet acquisition control
With AI/DI/DO,supports Modbus to TCP/MQTT/PLC protocol

4G Industrial VPN Router R40



Table of contents

1. Description	4
1.1 Brief Introduction	4
1.2 Typically Applications	5
1.3 Safety Directions	9
1.4 Standard Packing List	10
1.5 Main Features	10
1.6 Technical Parameters	12
2. Hardware Description	14
2.1 Size	16
2.2 Indicator light	16
2.3 Reset	17
2.4 SIM Card	17
2.5 Connect External Antenna	18
2.6 Router GND	18
2.7 Installation	19
3. Start up	19
3.1 Switch on	19
3.2 System running status	20
3.3 SIM Card Operation	20
3.4 Serial Port Instructions	21
3.5 Digital output Instructions	22
3.6 Digital input Instructions	23
3.7 Analog input Instructions	24
4. Preparation before configuration	24
4.1 Wired Connection	25
4.2 Wifi Connection	29
4.3. Factory Default Settings	31
4.4. Enter Web Settings	31
5. Router Settings	32
5.1 Status	32
5.2. System	33



4G Wireless Industrial Router

Wireless Data Connectivity

5.3. Service.....	37
5.4 Network.....	42
5.5 VPN.....	64
5.6 Serial Port.....	69
5.7 RTU IO.....	73
5.8 Logical Operation.....	78
5.9 Cloud Platform.....	79
5.10 Logout.....	85
6. Communication Protocol.....	85
6.1 Modbus RTU Protocol.....	85
6.2 MQTT Protocol.....	96
7. SMS Command List.....	100
8. Warranty.....	101

【UPGRADE HISTORY】

DATE	FIRMWARE VERSION	HARDWARE VERSION	DESCRIPTION
2020.03.13	V 1.0	V 1.0	<i>First edition</i>
2020.09.30	V1.1	V1.0	<i>Modify some configuration instructions</i>
2021.2.25	V1.2	V1.0	<i>Added link to Huawei Cloud IO platform</i>
2021.03.18	V1.3	V1.0	Add device mapping register address from 64-127 to 64-256
2021.09.30	V1.4	V1.0	(1) MQTT increases the release of only changing data; (2) Cellular network increase enable switch (3) Support MQTT custom release data format (4) The collection period and response timeout time of modbus master station are increased (5) Cycle timer to increase the start and end time and cycle times Settings (6) Add LAN/WAN switching function in network Settings (7) Add mount points and sharing functions



4G Wireless Industrial Router

Wireless Data Connectivity

Model	Serial Port	WAN	LAN	WIFI	Digital input	Digital output	Analog input	Extend function
R40	1RS485,1RS232	1	3	✓	2	2	x	Modbus slave/MQTT
R40A	1RS485,1RS232	1	3	✓	2	2	x	Modbus master/slave/MQTT
R40B	1RS485,1RS232	1	3	✓	2	2	4	Modbus master/slave/MQTT

1. Description

1.1 Brief Introduction

Router industrial router is an industrial IoT high-speed router, compatible with 4G/3.5G/3G/2.5G network, flagship

configuration, VPN link, industrial protection, wide temperature, wide voltage design, easy to set up high speed, stable The wireless transmission network uses the public LTE network to provide users with wireless long-distance data transmission, It is with 4 AI+2DI+2DO for options,can be used in multiple industrial applications.

It is an industrial-grade multifunctional Internet of Things terminal device that supports POE power supply, comes with IO input and output, with 2 serial ports, supports transparent transmission, Modbus Master protocol for expanding IO and connecting PLC and other devices. It adopts dual SIM card redundancy design to ensure stable and reliable data transmission, supports MQTT protocol and Modbus protocol, and is compatible with most PLC protocols, greatly simplifying on-site wiring construction costs and reducing operation and maintenance costs.

High-performance industrial-grade cellular router adopts 32-bit processor, developed based on Linux system, supports GSM/2G/3G/4G/GPRS/EDGE/WCDMA/HSPA+/LTE network, provides high-speed wireless network bandwidth for the device through wireless connection, and has automatic detection of network disconnection, automatic restart of dial-up failure, and scheduled restart to ensure network Stable connection.

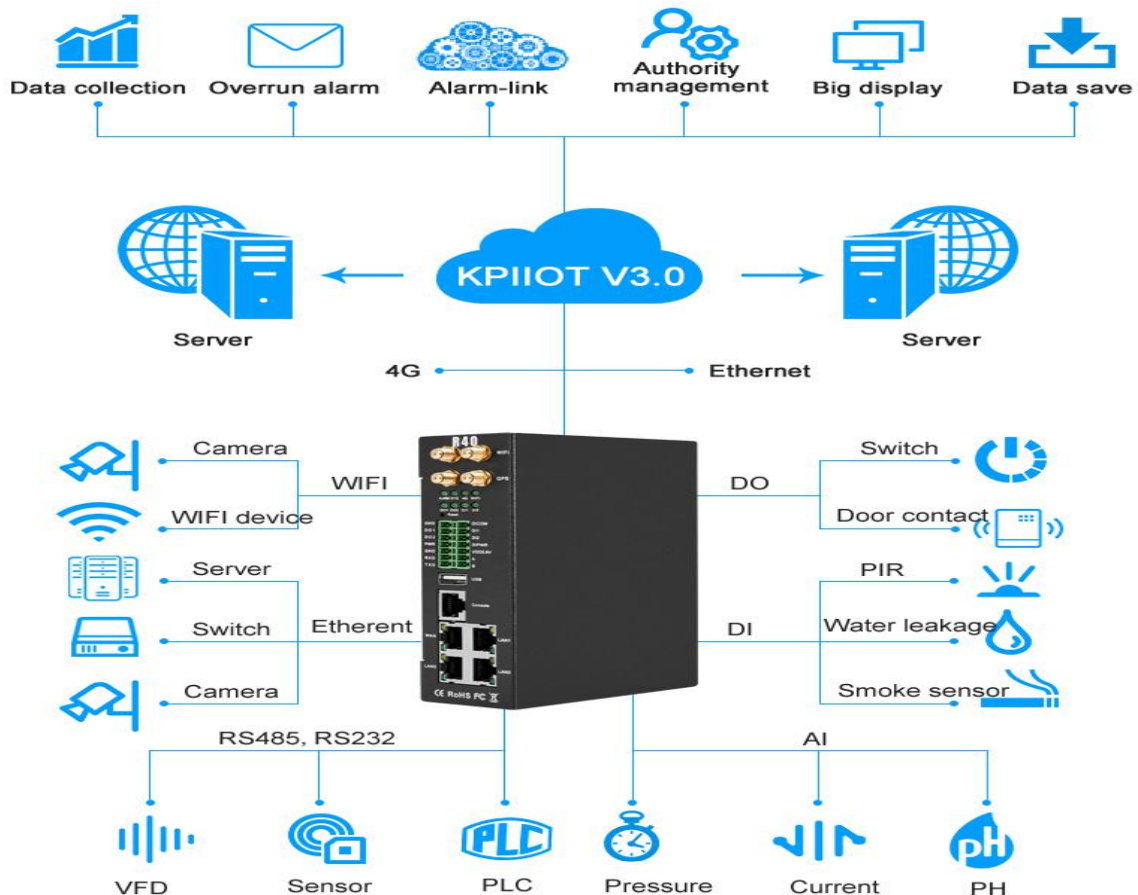













1.2 Typically Applications

BTS Monitoring, Security Alarm System applications, Supervision and monitoring alarm systems, Automatic monitoring system, Vending Machines security protection, Pumping Stations, Tanks, Oil or Water levels, Buildings and Real Estate, Weather Stations, River Monitoring and Flood Control, Oil and gas pipelines, Corrosion protection, Temperatures, water leakage applications, Wellheads, boat, vehicle, Energy saving, street lights control system, Valve controls, Transformer stations, Unmanned machine rooms, Control room application, Automation System, M2M, etc.

Industry Application

APPLICATION INDUSTRY

 <p style="background-color: #007bff; color: white; padding: 5px; display: inline-block;">Smart Transportation</p>	 <p style="background-color: #007bff; color: white; padding: 5px; display: inline-block;">Smart Energy</p>	 <p style="background-color: #007bff; color: white; padding: 5px; display: inline-block;">Smart Retail</p>
 <p style="background-color: #007bff; color: white; padding: 5px; display: inline-block;">Smart Factory</p>	 <p style="background-color: #007bff; color: white; padding: 5px; display: inline-block;">Smart Building</p>	 <p style="background-color: #007bff; color: white; padding: 5px; display: inline-block;">Smart City</p>
 <p style="background-color: #007bff; color: white; padding: 5px; display: inline-block;">Smart Agriculture</p>	 <p style="background-color: #007bff; color: white; padding: 5px; display: inline-block;">Smart Security</p>	 <p style="background-color: #007bff; color: white; padding: 5px; display: inline-block;">Smart Logistics</p>
 <p style="background-color: #007bff; color: white; padding: 5px; display: inline-block;">Smart School</p>	 <p style="background-color: #007bff; color: white; padding: 5px; display: inline-block;">Smart Community</p>	 <p style="background-color: #007bff; color: white; padding: 5px; display: inline-block;">AI</p>



4G Wireless Industrial Router Wireless Data Connectivity

1.2.1 Tunnel wireless remote monitoring solution

R40 4G industrial VPN wireless router is used in tunnel remote monitoring system to monitor environmental quality, ventilation system, water supply and drainage fire protection system, lighting system, traffic guidance system monitoring and remote manual control or automatic control.

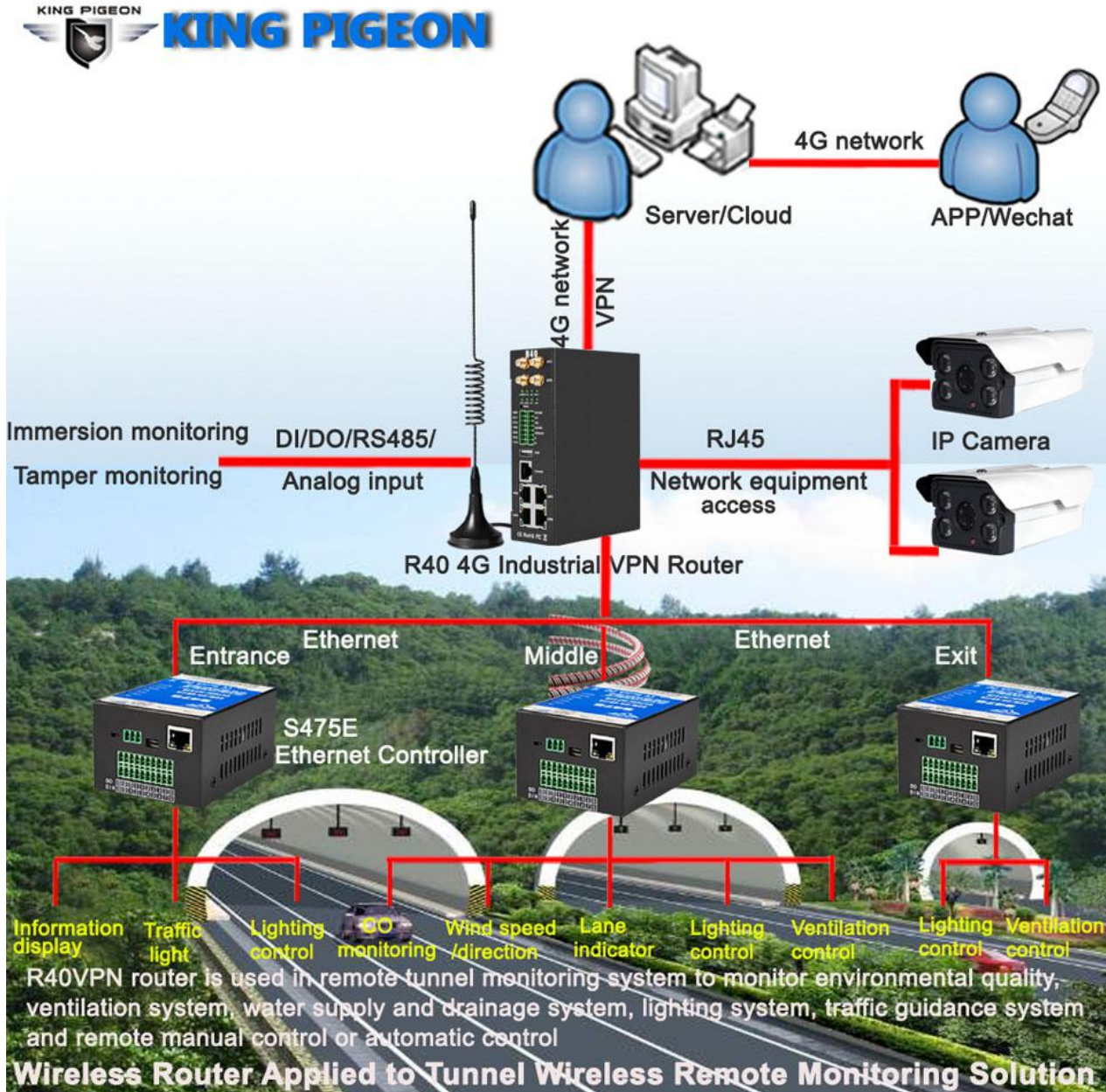



4G Wireless Industrial Router Wireless Data Connectivity

1.2.2 Water Conservancy Wireless Monitoring Solution

R40 4G industrial VPN wireless router is used in reservoir dams, canals, rivers to achieve wireless remote video, flow, rainfall, water level, water quality routine 5 parameters, dam safety, water pumps and other data collection and control.

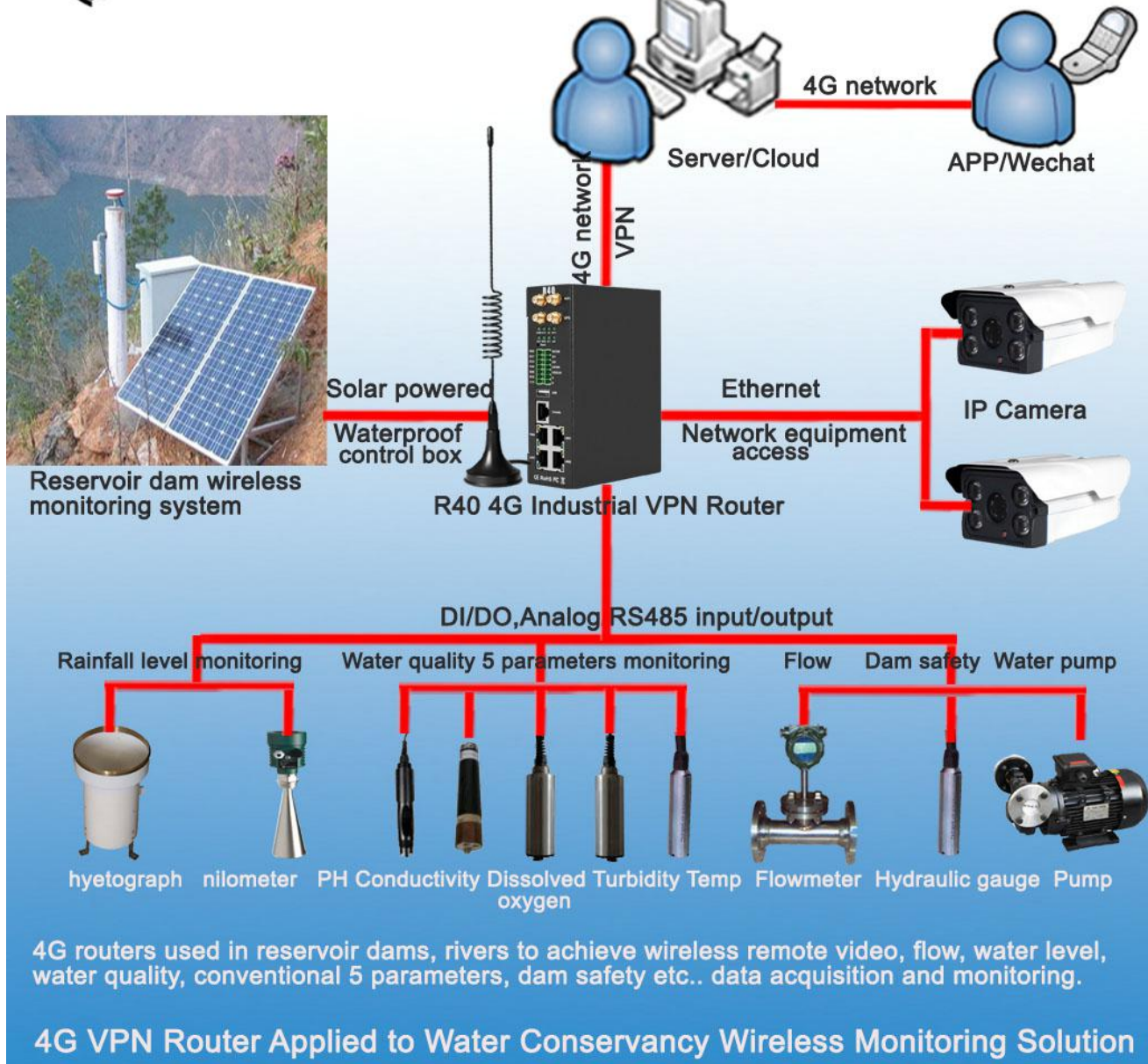



4G Wireless Industrial Router

Wireless Data Connectivity

1.2.3 Smart Environmental Protection Wireless Monitoring Solution

R40 4G industrial VPN wireless router is used in the smart environmental protection industry to realize wireless remote video, rainfall, wind speed, wind direction, PM2.5, PM10, temperature and humidity, air pressure and other data collection and automatic or remote control fog cannon.

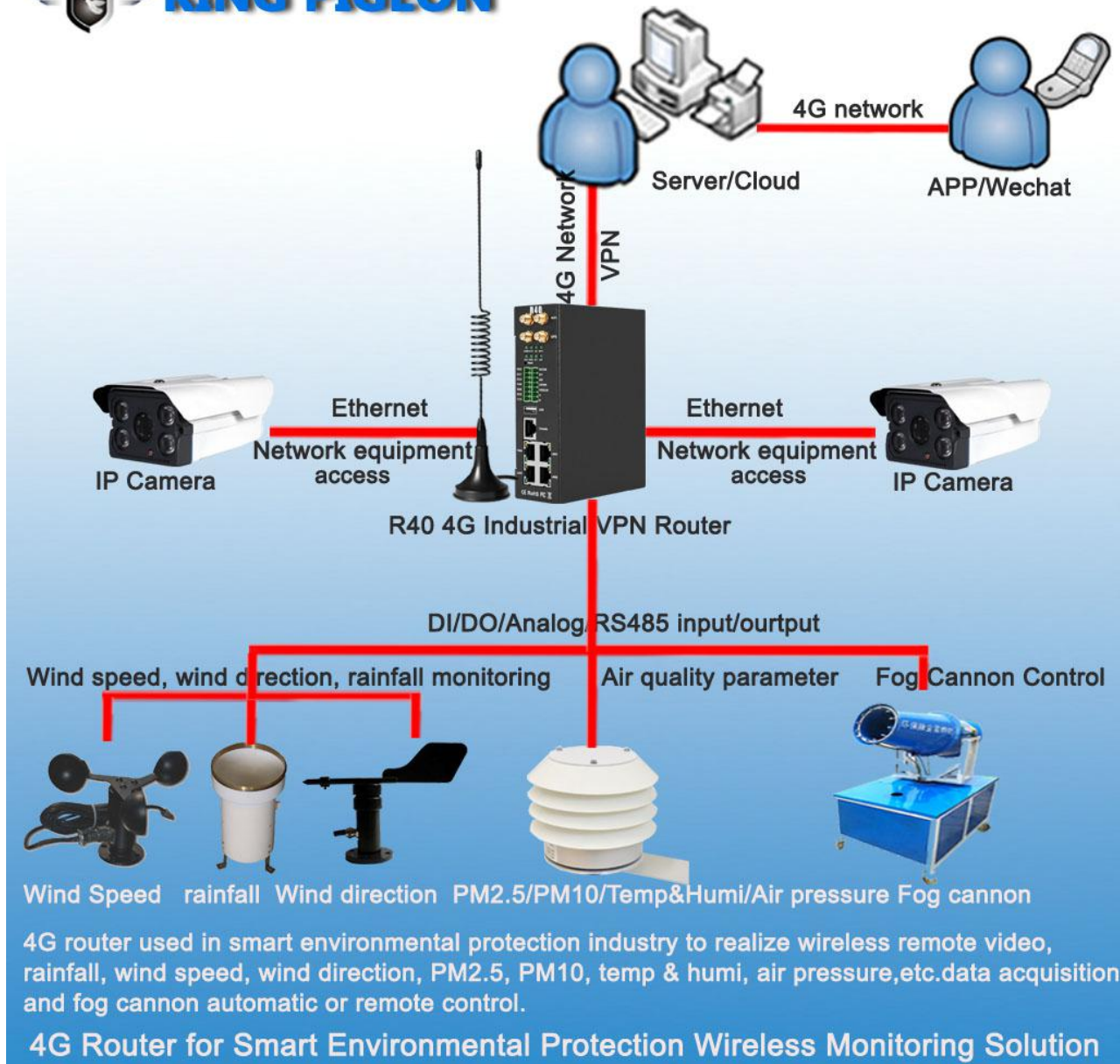



4G Wireless Industrial Router Wireless Data Connectivity

1.2.4 Mine Wireless Networking & Monitoring System Solution

R40 4G industrial VPN wireless router is used in mines to provide data collection and control of wireless workstation network access, wireless video surveillance, combustible gases, dust, temperature, water immersion, water pumps, motors, motors, PLCs, etc.

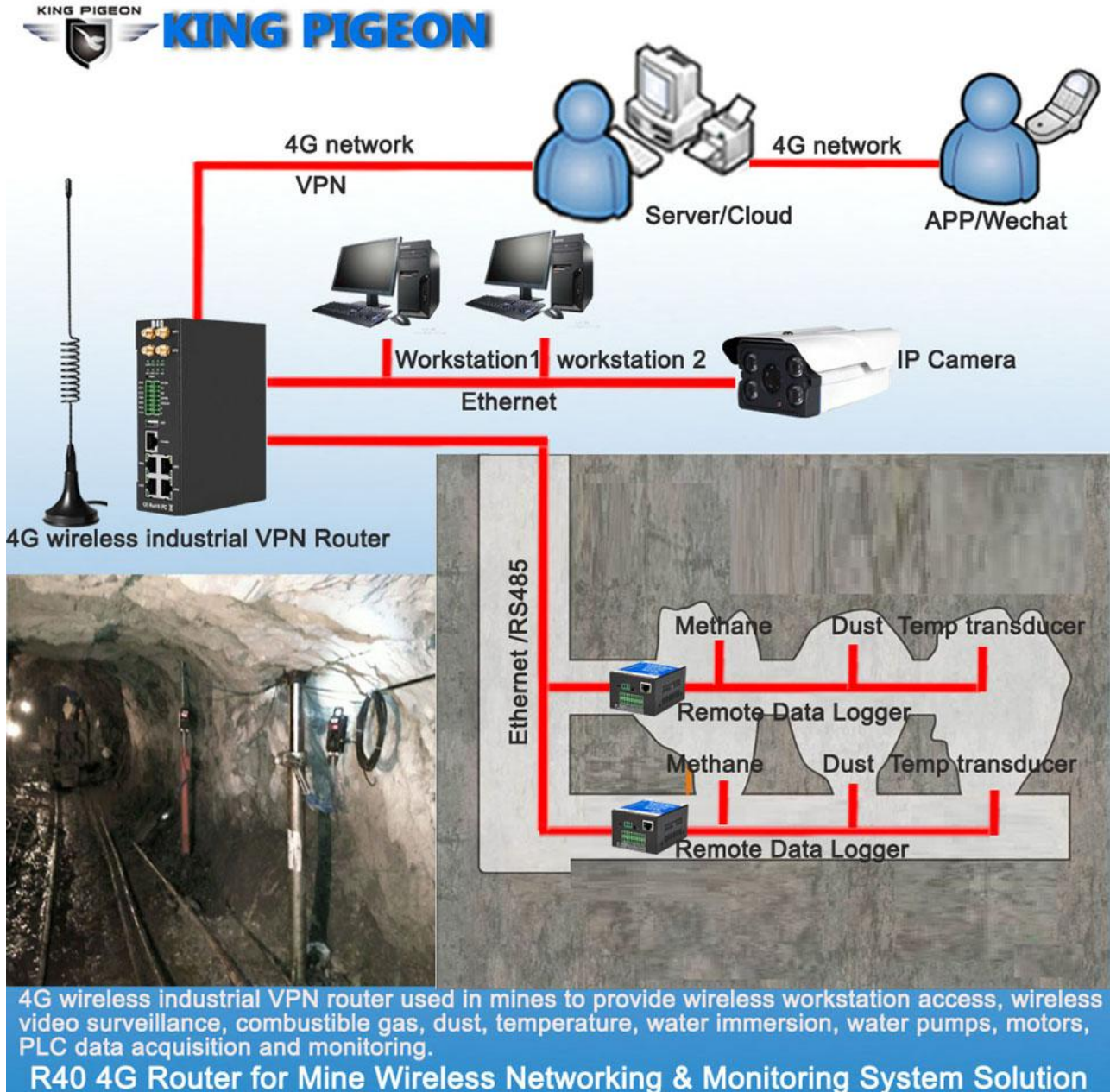

1.3 Safety Directions



Safe Start up

Do not use the unit when using GSM/3G/4G equipment is prohibited or might bring disturbance or danger.



Interference

All wireless equipment might interfere network signals of the unit and influence its performance.

1.4 Standard Packing List

Router R40 X1, Power adaptor*1, GSM/3G/4G Antenna X1, 2.4G WIFI Antenna X3,
User Manual X1, Wall-mounted snap kit x 2, 35mm Standard DIN rail fixed Bracket*1.



Note: The package does not include any SIM card.

1.5 Main Features

- DIN(2 channel) :Support NO/NC/counting input, frequency<100, can set counting threshold, support alarm trigger.
- DO(2 channel): can be set according to the trigger condition.
- AIN(4 channel): Support 0-5V, 0-20mA, 4-20mA, can set threshold value, support alarm trigger.
- Support SMS to query DI/DO/AI status and value, and set DO status;
- Support 4G wireless Internet access function, can set APN and other parameters;
- Two SIM card slots, support dual card switching;
- Support GPS, positioning data can be released through MQTT;
- VPN: Support L2TP, IPSEC, OPENVPN and other VPN protocols.
- Interface: Support RS485 and RS232 serial port transparent transmission and MODBUS RTU to TCP, Support MODBUS master, can regularly read MODBUS slave node data through RS485, RS232 and Ethernet.



4G Wireless Industrial Router

Wireless Data Connectivity

- Support address mapping, mapping RS485, RS232 and Ethernet access device addresses to router local addresses.
- Support monitoring the online status of network devices connected to the LAN port, which can be reported to the platform through MODBUS or MQTT.
- Link switching: Support WAN port and 4G network connection switching, preferentially use WAN port wired network.
- Platform connection: Support MODBUS and MQTT protocols, MQTT supports SSL encryption.
- Alarm: Supports SMS and e-mail alarm.
- Timer: Support one-time timer and period timer.
- Upgrade: Support remote upgrade through webpage

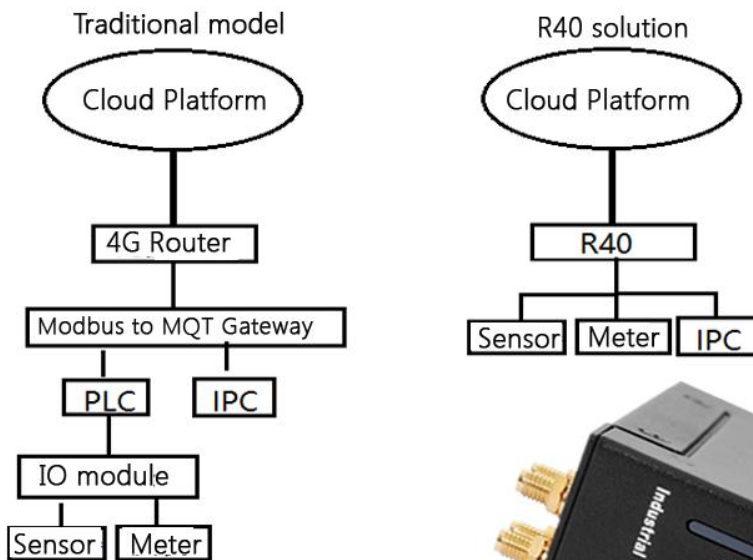

Advantage:

1. Low hardware cost
2. Less hardware connection, low error probability
3. Small installation space and easy construction
4. Simplified architecture and low maintenance cost
5. Humanized design, no PLC programming required





4G Wireless Industrial Router

Wireless Data Connectivity

1.6 Technical Parameters

Item	Parameters	Description
Power Supply	Input voltage	9~57VDC
	Input current	Normal:240mA@12V,max:800mA@12V
	Connection	5.08mm terminals
	Protection	Anti-reverse connection Protection
WAN	Qty	1
	Interface Spec	RJ45,10/100Mbps,Automatically adapted to MDI/MDIX
	Protection	ESD $\pm 30\text{kV}$ (contact) , $\pm 30\text{kV}$ (air) EFT 40A (5/50ns) Lightning strike 24A (8/20 μs)
LAN (POE)	Qty	3
	Interface Spec	RJ45,10/100Mbps,Automatically adapted to MDI/MDIX
	POE(optional)	Supports 3 POE power output compatible IEEE802.3at/af Single POE maximum output power 30W With power management function Voltage range 48~57V
	Protection	ESD $\pm 30\text{kV}$ (contact) , $\pm 30\text{kV}$ (air) EFT 40A (5/50ns) Lightning strike 24A (8/20 μs)
Serial Port	Qty	2
	Type	1 RS485,1 RS232
	Baudrate	1200, 2400, 4800, 9600, 14400, 19200, 38400, 57600, 115200, 230400
	Data Bit	5, 6, 7, 8
	Parity	None, Even, Odd
	Stop Bit	1,2
	Working mode	Data transparent transmit,Modbus RTU to TCP,Modbus master
	Protection	ESD (contact) : 8KV Surge: 4KV (8/20us) ESD $\pm 8\text{kV}$ (contact) , $\pm 15\text{kV}$ (air) EFT 4KV, 40A (5/50ns)
Console	Qty	1
	Type	CONSOLE
	Interface Spec	RJ45
	Protection	ESD: $\pm 8\text{kV}$ (contact) , $\pm 15\text{kV}$ (air)
USB (Reserved)	Qty	1
	Type	USB2.0 (HOST)
	Protection	ESD $\pm 8\text{kV}$ (contact) , $\pm 15\text{kV}$ (air)
WIFI	Antenna qty	2
	Antenna type	SMA
	protocol	802.11a/b/g/n (mixed)
	mode	AP mode,client mode



4G Wireless Industrial Router

Wireless Data Connectivity

	Frequency	2.4G
	Channel	Channel 1 - 13
	Security	Open,WPA,WPA2
	Encryption	AES,TKIP,TKIPAES
	Connection number	16 (Max)
	Speed	300Mbps (Max)
	Transmit Distance	Outdoor non-blocking/opening, covering up to 20 meters
	SSID Broadcast Switch	support
Cellular Network	Antenna Port Qty	1
	Antenna Port Type	SMA
	4G (L-E)	GSM/EDGE: 900,1800MHz WCDMA: B1,B5,B8 FDD: B1,B3,B5,B7,B8,B20 TDD: B38,B40,B41
	4G (L-AU)	GSM/EDGE: 850,900,1800MHz WCDMA: B1,B2,B5,B8 FDD: B1,B2,B3,B4,B5,B7,B8,B28 TDD: B40
	4G (L-A)	WCDMA: B2,B4,B5 FDD: B2,B4,B12
	4G (L-V)	FDD: B4,B13
	4G (L-J)	WCDMA: B1,B3,B8,B18,B19, B26 FDD: B2,B4,B12 TDD: B41
	4G (L-CE)	GSM/EDGE: 900,1800MHz WCDMA: B1,B8 TD-SCDMA: B34,B39 FDD: B1,B3,B8 TDD: B38,B39,B40,B41
SIM	Qty	2
	Interface Spec	Drawer interface,supports 1.8V/3V SIM/UIM 卡 (NANO)
	Protection	In-built 15KV ESD Protection
GPS (optional)	Antenna qty	1
	Antenna type	SMA
	Tracking Sensitivity	> -148 dBm
	Horizontal Accuracy	2.5m
	Protocol	NMEA-0183 V2.3
Digital input	Qty	2
	Type	Switch contact signal (dry node) or level signal (wet node)
	range	1:High level, 5~30VDC, close signal ;0:low level 0~1VDC open signal
	Pulse frequency	Max 100Hz
	Protection	Isolation voltage 3750Vrms
Digital output	Qty	2
	Type	SINK output



4G Wireless Industrial Router

Wireless Data Connectivity

	Load voltage	Max 50VDC
	Load current	500mA (single) , 625mW
	Protection	EFT: 40A (5/50ns)
Analog input	Qty	4
	Type	0~5V, 4~20mA, 0~20mA
	ADCResolution	16bit
	Protection	EFT: 40A (5/50ns)
Indicator light	ALARM	Alarm indicator light
	SYS	System running status indicator
	4G	4G status indicator
	WiFi	WiFi status indicator
	DO1,DO2	Digital output indicator light
	DI1,DI2	Digital input indicator light
System	CPU	MIPS CPU,Clock Speed 580Mhz
	Storage	16MB (Scalable to 32MB)
	RAM	128MB (Scalable to 256MB)
Software	Network Portocol	PPP, PPPoE, TCP, UDP,DHCP, ICMP,NAT, HTTP, HTTPs,DNS, ARP, NTP,SMTP,SSH2,DDNS etc.
	VPN	Ipsec,OpenVPN,L2TP
	Firewall	DMZ,DoS defense,IP packet, Domain name and MAC address filtering, port mapping, access control
	Remote Management	Support web remote configuration
	System Log	support
	Firmware Upgrade	Support serial port local TFTP/web firmware upgrade
Certificate	EMI	EN 55022: 2006/A1: 2007
	EMS	IEC(EN)61000-4-2(ESD) IEC(EN)61000-4-3(RS) IEC(EN)61000-4-4(EFT) IEC(EN)61000-4-5(Surge) IEC(EN)61000-4-6(CS) IEC(EN)61000-4-8
	Others	CE,FCC,ROHS,3C
Working Enviornment	Working temperature	-40~85℃
	Storge temperature	-40~105℃
	Humidity	5~95%RH
Others	Enclosure	Metal
	Size	H145mm * L110mm * W45mm
	IP level	IP30
	Net weight	790g
	Installation	Wall-amount/ rail-amount

2. Hardware Description

2.1 Size

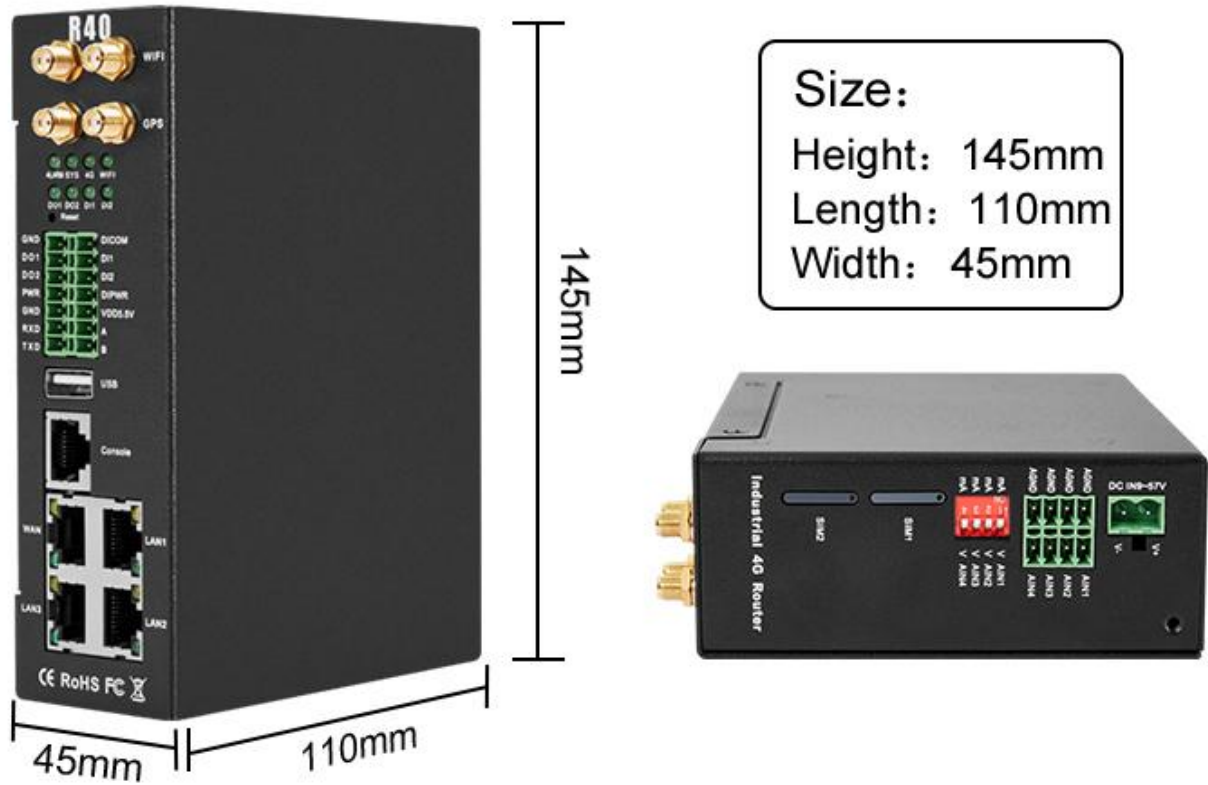

2.2 Indicator light

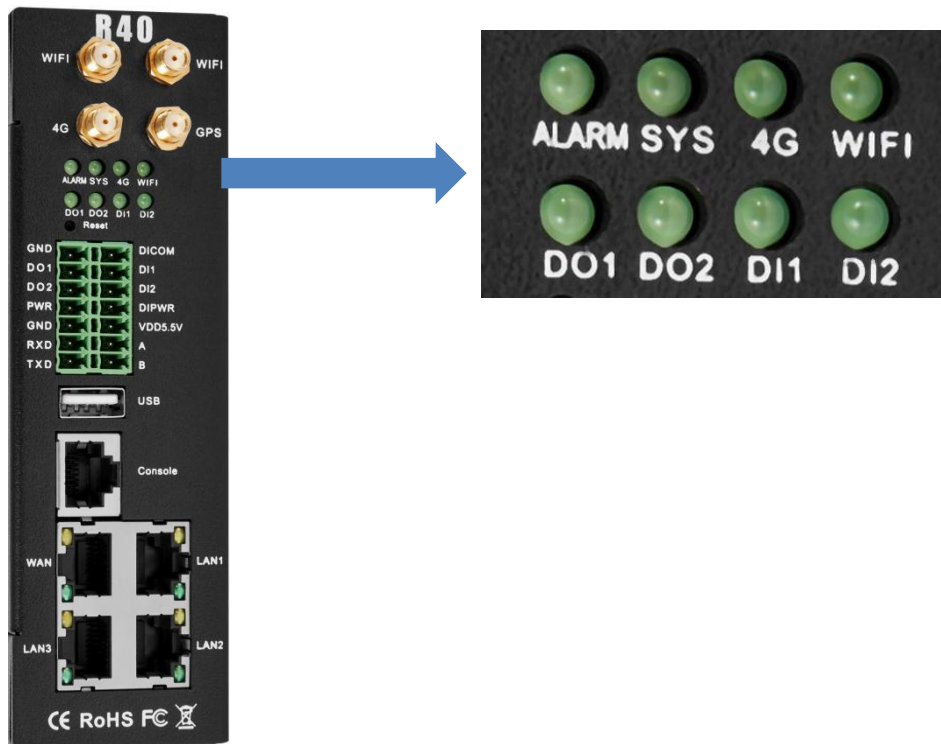

LED Indicator light			
Name		status	Description
ALARM	Alarm indicator light	ON	DI or AI trigger alarm
		OFF	normal
SYS	System running status indicator	flicks slowly	normal
		OFF	abnormal
4G	4G status indicator	flicks fast	Signal normal
		OFF	abnormal
WIFI	WiFi status indicator	ON	WiFi normal
		OFF	abnormal
DO1	Digital output 1 indicator light	ON	DO1 close
		OFF	DO1 open
DO2	Digital output 2 indicator light	ON	DO2 close
		OFF	DO2 open
DI1	Digital input 1 indicator light	ON	DI1 close
		OFF	DI1 open
DI2	Digital input 2 indicator light	ON	DI2 close

2.3 Reset

After the router runs normally, use a pointed stick to continue to hold down the Reset button for about 10 seconds until the WAN port indicator flashes slowly. At this time, restart the router to restore the factory default settings.



2.4 SIM Card

When inserting/removing the SIM card, first make sure that the device is turned off, insert the card take-out pin into the small hole of the card slot, press it slightly to push the card slot out.



Drawer
Nano SIM
card slot

2.5 Connect External Antenna



WiFi antenna

GPS antenna

4G antenna

2.6 Router GND

The router ground wire helps prevent the effects of electromagnetic interference. Before connecting the device, ground the device through the ground screw connection. Note: This product should be installed on a well-grounded device surface, such as a metal plate.

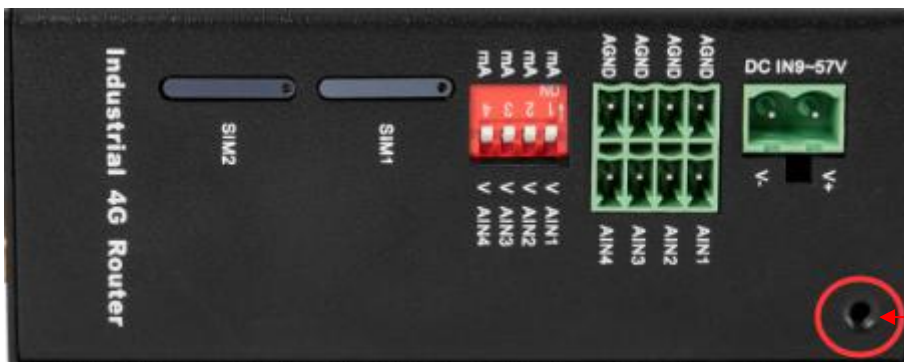

GND

2.7 Installation

This device supports horizontal desktop placement, wall mounting and rail mounting.

2.7.1 Wall-mounted installation

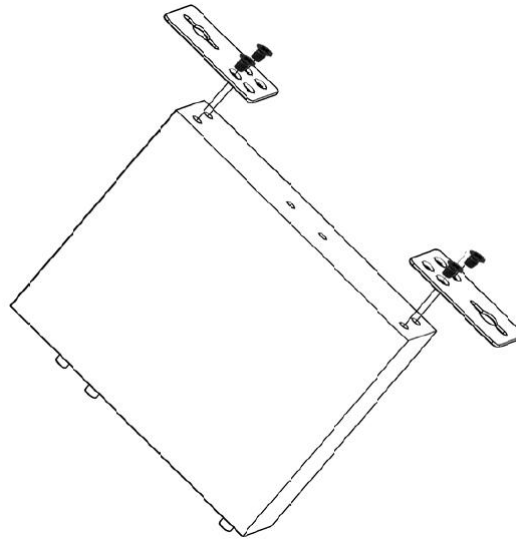

2.7.1 Rail mounting

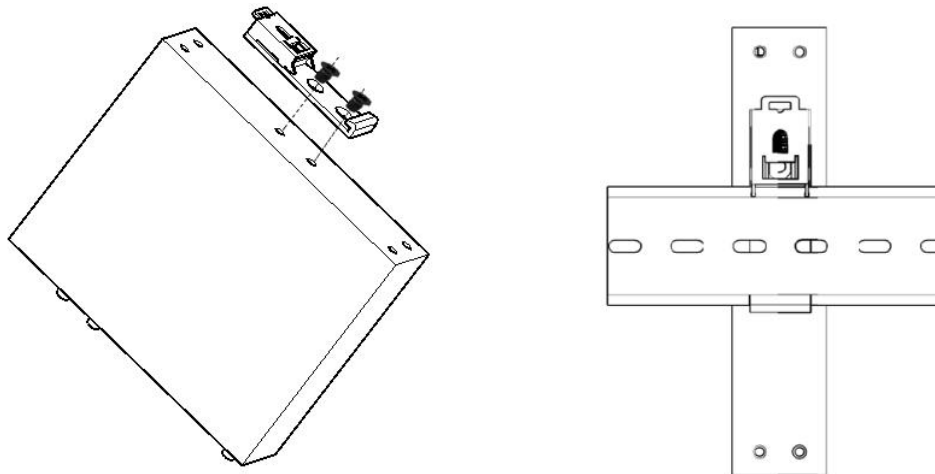

3. Start up

3.1 Switch on

Power input port: R40 uses 9 ~ 57V DC voltage for power supply. If you need POE power supply

then power supply must meet 44V ~ 57V DC voltage power supply (recommend 48V / 2A).



3.2 System running status

Observe the system running status indicator -SYS, slow blinking indicates that the device starts normally.



3.3 SIM Card Operation

The device supports dual SIM cards (only supports NANO SIM cards). When installing the card, please disconnect the power of the device, remove the card holder with the card take-out pin, install the NANO SIM card into the card holder according to the position, and then insert the card holder back into the card slot, then power on the device again.

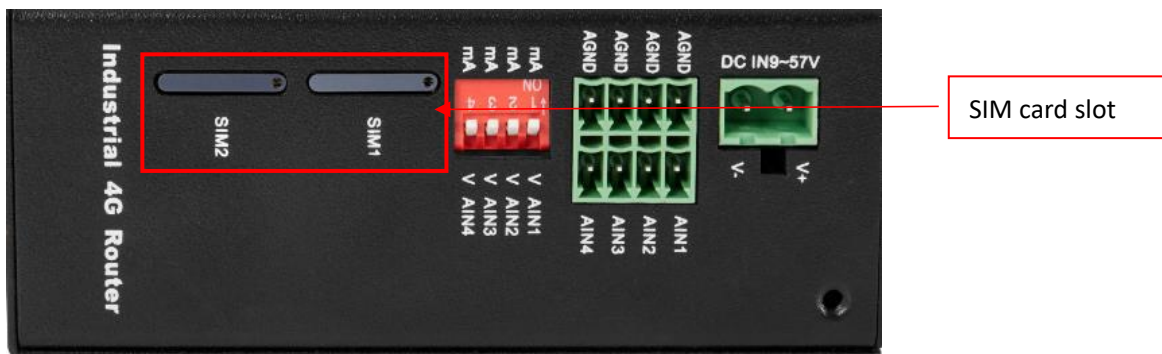

After the device is powered on, enter the router configuration interface-network-cellular network, you can view the cellular network registration status.

4G cellular network dial-up networking defaults to use SIM card 1, if you need to use SIM card 2, you need to enter the cellular network configuration interface, select card 2 in the column of selecting a phone card, save and apply to switch.

The dual card redundancy design of R40 can automatically switch to another SIM card for communication when the current SIM card network communication is abnormal (one minute).

For detailed configuration, please refer to 5.4.1.4.4G interface and 5.4.3 cellular network.



4G Wireless Industrial Router

Wireless Data Connectivity

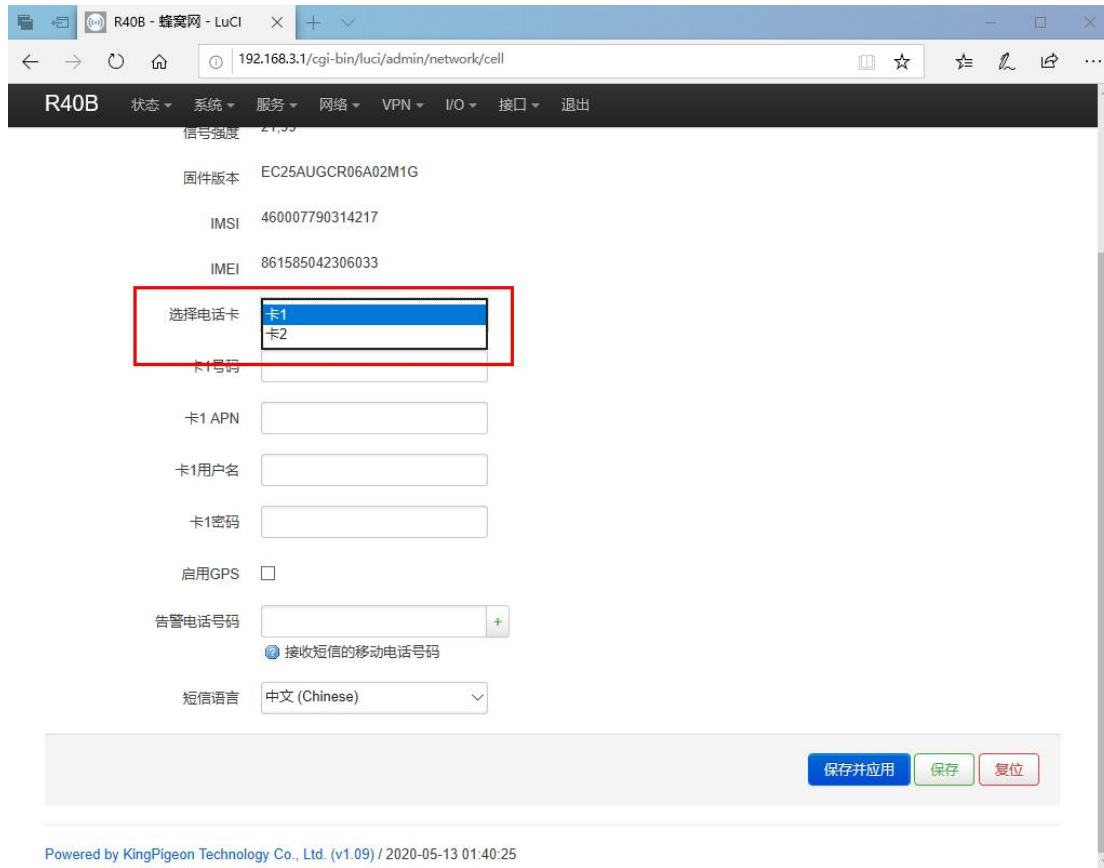

3.4 Serial Port Instructions

The device has an RS485 and an RS232 communication interface, which can be used for Modbus master station (optional model to support), Modbus slave station, transparent transmission, Modbus RTU to TCP and other communications.

Note: Only one of the functions can be selected for the same serial port at the same time, and it cannot be reused. If it is found that the serial port cannot be selected on the configuration page, it means that the serial port has been set on the other function configuration page; different serial ports do not affect each other.

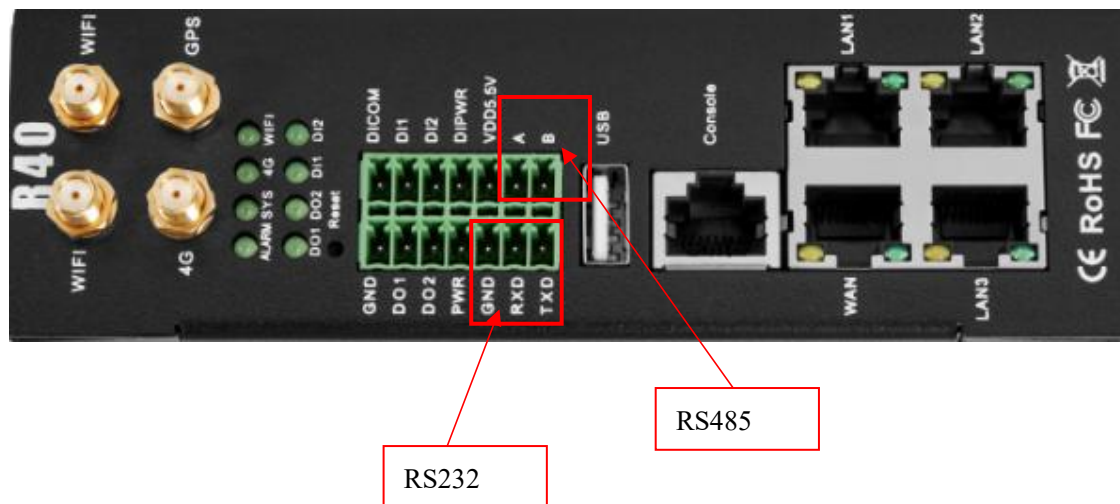

3.4.1 Modbus Master

Modbus master : Used as Modbus master, the serial port connected to Modbus slave equipment, through



configuration Page [5.6.3. Modbus maste configures](#) slave register and serial port parameters, the host collect slaves data through Modbus RTU protocol, and store the slave data in the local mapping register, can query the slave data directly on the configuration page, or you can [6.1.1. Cloud connection settings](#): Configure Modbus protocol or MQTT protocol to upload slave data to the server to realize Modbus RTU protocol to MQTT protocol.

When the RS485 or RS232 selected as the "Modbus RTU master", or the corresponding slave IP is set on the Ethernet, the device will actively poll the slave device in accordance with the Modbus RTU or Modbus TCP protocol, and put the slave device in The value of the register is read into the device's mapping area for storage. In this way, the registers in the slave are mapped to the device, and reading and writing the mapped registers of the device will be directly transmitted to the slave device through the RS485 serial port, RS232 serial port or network port. There is a one-to-one correspondence between the slave register address and the mapped register address in this device. This is the mapping register list.

Users can connect various slaves through RS485 serial port, RS232 serial port or Ethernet port, supporting up to 48 slave devices, so as to realize the function of adding I/O ports and reading and writing smart meters and smart devices. For example, connect to the remote I/O modules of the Mxxx series to expand the number of DIN, DO, AIN, AO, PT100 input ports, or connect the power parameter monitoring module to read the current, voltage, power of the three-phase electricity, or connect to the UPS power supply for Parameter monitoring, etc. Or the combination of the above various smart devices, etc., can meet the functional requirements of most applications.

3.4.2 Modbus Slave

Modbus slave function: When used as Modbus slave , the serial port will be connected to the Modbus master device. Configure the serial port parameters through the configuration page [6.1](#). Modbus slave, the master device will be able to collect the local I/O data through Modbus RTU or TCP protocol.

3.4.3 Transparent transmission

The device used as a data transfer station between the server and the slave device,through the configuration page 5.7.4. It transparently transmits the data uploaded from the slave to the server, and sends the data to the server Transparent transmission to the slave, without processing the data content, only forwarding data, to achieve data transparent transmission function.

3.4.4 Modbus RTU to TCP

Master communicate with slave via Modbus RTU protocol, master communicate with slave via Modbus TCP protocol,through the [configuration page 5.6.](#)

The device automatically converts Modbus TCP commands issued by the server into Modbus RTU commands and sends them to the slave, and then converts the Modbus RTU commands returned from the slave into Modbus TCP commands and replies to the server, so that the Modbus RTU slave device and the Modbus TCP server can be realized communication.

3.5 Digital output Instructions

3.5.1 Wiring

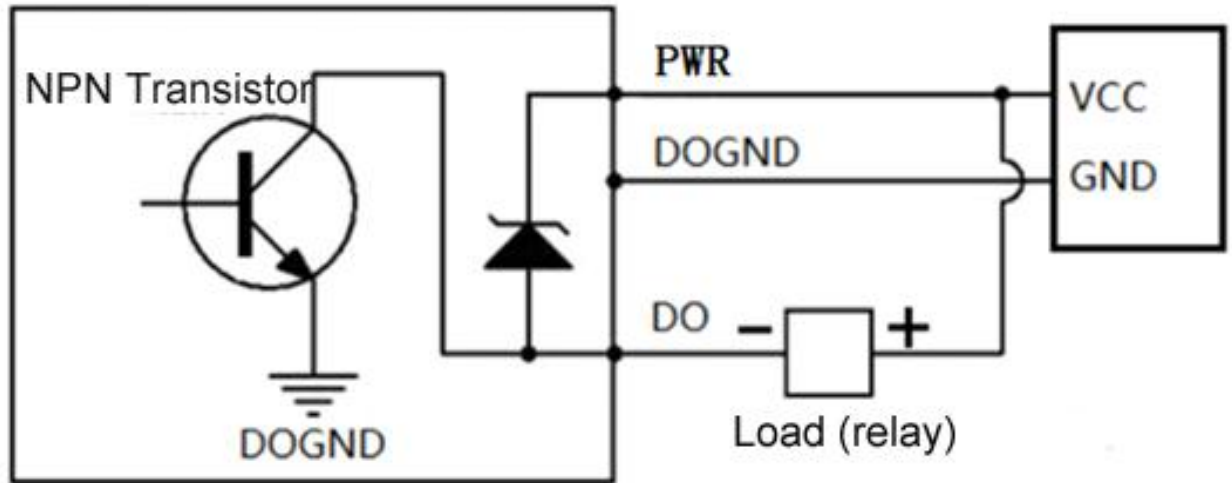

3.5.2 DO instruction:

Digital output	qty	2
	type	SINK output
	Load voltage	Max 50VDC
	Load current	500mA (single) ,625mW
	protection	EFT: 40A (5/50ns)

1. DO1~DO2 are two-way NPN transistor open-collector output, and PWR is the clamp protection for the external power supply of the common terminal.
2. Digital output setting: Enter the router configuration interface-RTU I/O-digital input and output, and you can enable/disable or query and set the digital output status at the digital output port.
3. Trigger setting: According to the state of DI digital input or AIN analog input, you can set the trigger condition and control the DO digital output operation (the confirmation time is X seconds after the trigger condition is reached).
4. For detailed configuration, please refer to 5.7.2. Digital input and output.

3.6 Digital input Instructions

3.6.1 Wiring

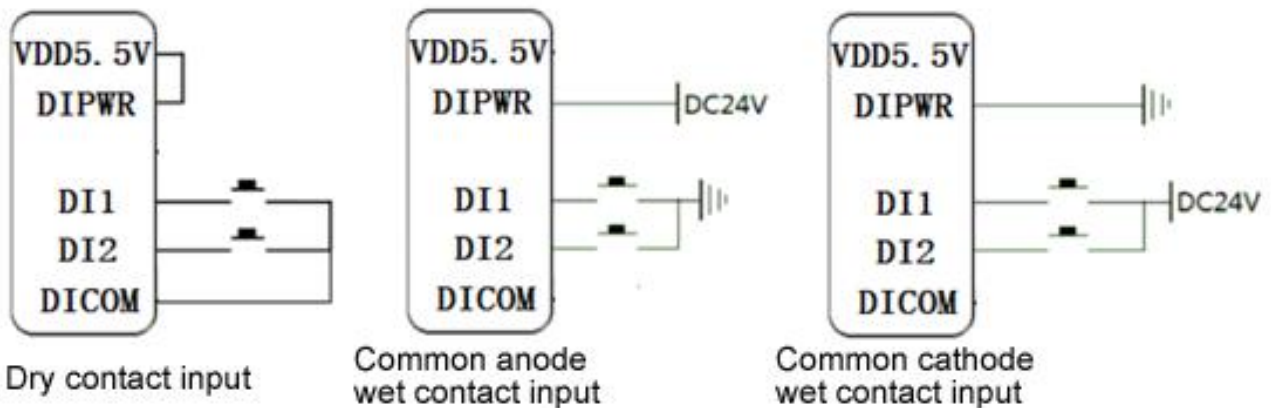

3.6.2 DI instruction:

Digital input	qty	2
	type	Dry contact,wet contact

	Range	High level (digital 1) 5~30VDC, low level (digital 0) 0~1VDC
	Pulse frequency	<100Hz
	protection	Isolation voltage 3750Vrms

1. DI1~DI2 are two digital inputs. The default is wet contact input. Short-circuit VDD5.5V and DIPWR to switch to dry contact input.
2. Digital input setting: enter the router configuration interface-RTU I/O-digital input and output, and you can enable/disable or query the digital input status and pulse count value at the digital input port.
3. Trigger setting: The trigger condition can be set according to the DI digital input state to control DO digital output, restart and other operations (the confirmation time is X seconds after the trigger condition is reached).
4. For detailed configuration, please refer to 5.7.2. Digital input and output.

3.7 Analog input Instructions

3.7.1 Wiring

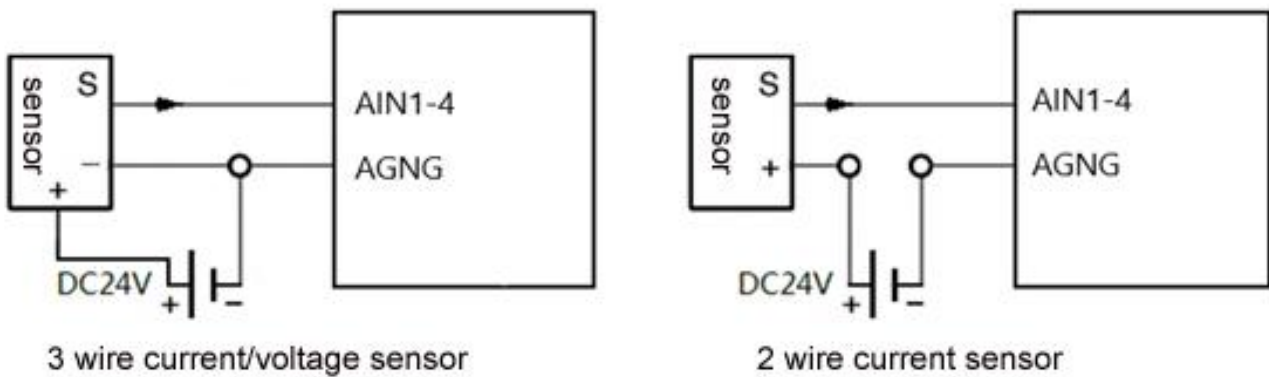

3.7.2 AI instruction:

Analog input	qty	4
	type	0~5V,4~20mA,0~20mA
	ADC resolution	16 bit
	Pulse frequency	<100Hz
	protection	EFT: 40A (5/50ns)

1. AI-AI4 is a four-way analog input, the default is 0~5V voltage type analog input, you can switch to current type analog input by turning the dial switch to mA. The four-way dial switch AI1~AI4 is Four analog inputs correspond one to one, V corresponds to voltage type, and mA corresponds to current type.
2. Analog input setting: enter the router configuration interface-RTU I/O-analog input, in the mode you can select voltage 0~5V, current 4~20mA, current 0~20mA (note that the DIP switch should also be selected Corresponding mode), set the range in the minimum and maximum values, you can see the actual measured value in the current value.
3. Trigger settings: The trigger conditions can be set according to the AIN status to control DO digital output, restart and other operations (the confirmation time is X seconds after the trigger condition is reached).
4. For detailed configuration, please refer to 5.7.3. Analog input

4. Preparation before configuration

The router supports web page configuration. There are two ways to connect the router. One is to connect the computer to any LAN port of the router through a wired connection; the other is to connect to the router through WIFI. The computer can automatically obtain IP through DHCP, or you can set a static IP on the same

network segment as the router. After the connection is established, enter the router's default login address 192.168.3.1 on the computer browser to enter the router's WEB login interface. The default login The user name is admin and the password is blank.

4.1 Wired Connection

There are two ways to configure its IP address on PC, one is to enable automatic IP address acquisition on the local connection of the PC, and the other is to configure a static IP address on the same subnet as the router on the local connection of the PC.

Setting on Windows 7 as an example:

1. Click "Start> Control Panel> Network and Sharing Center", double-click "Local Area Connection" in the window.

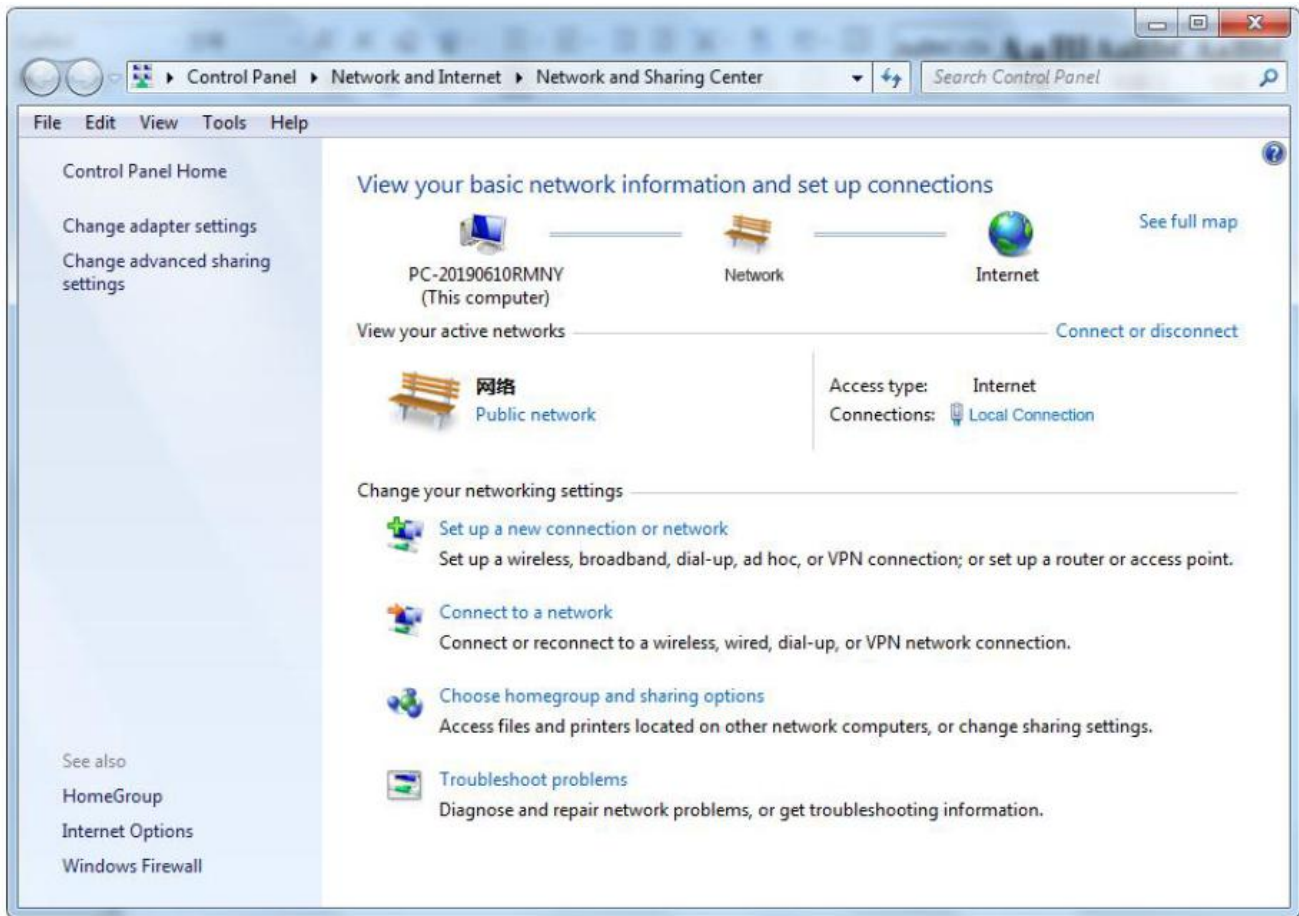

5. In the "Local Connection Status" window, click Properties.

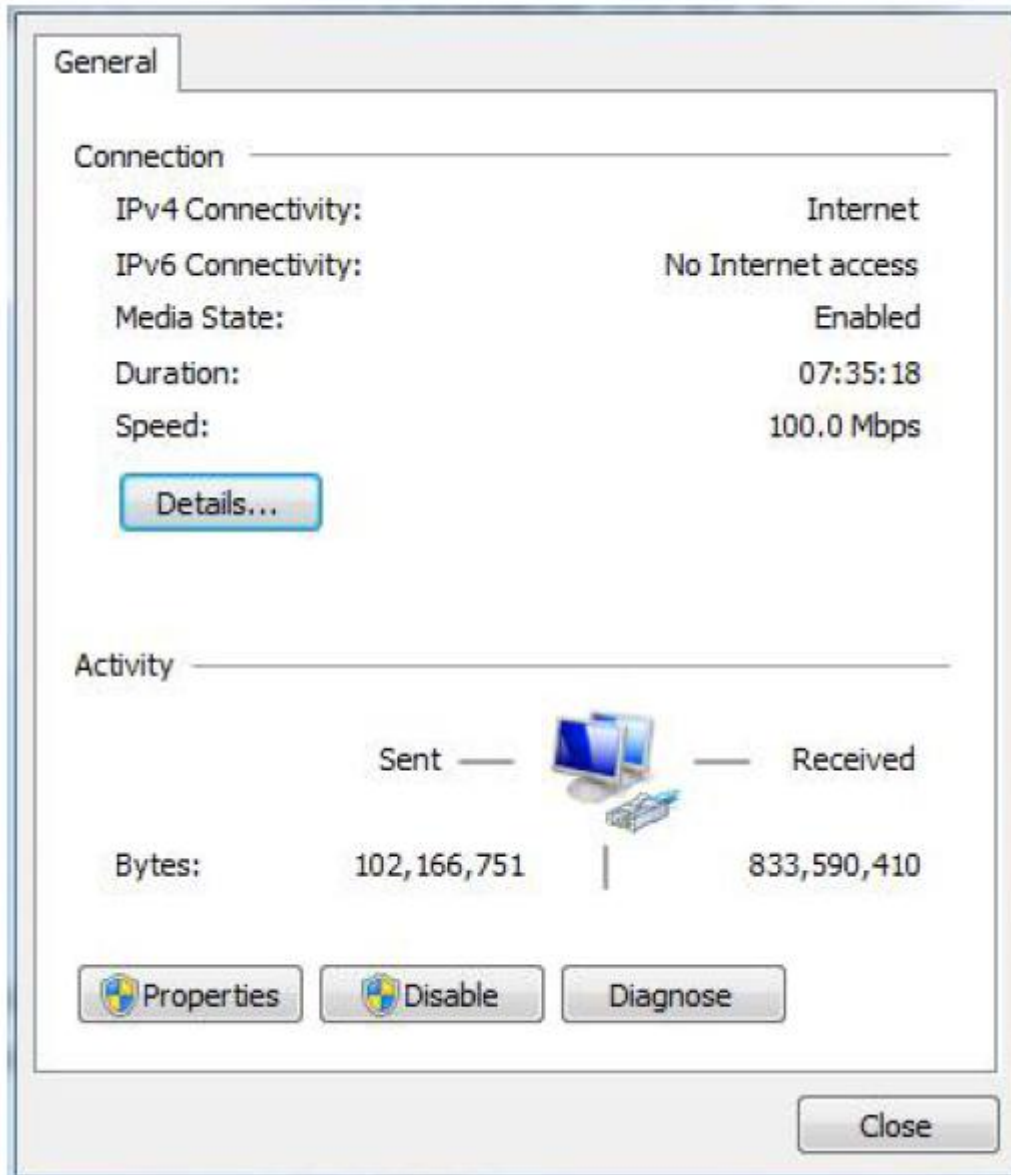

3. Select "Internet Protocol Version 4 (TCP/IPv4)" and click "Properties".

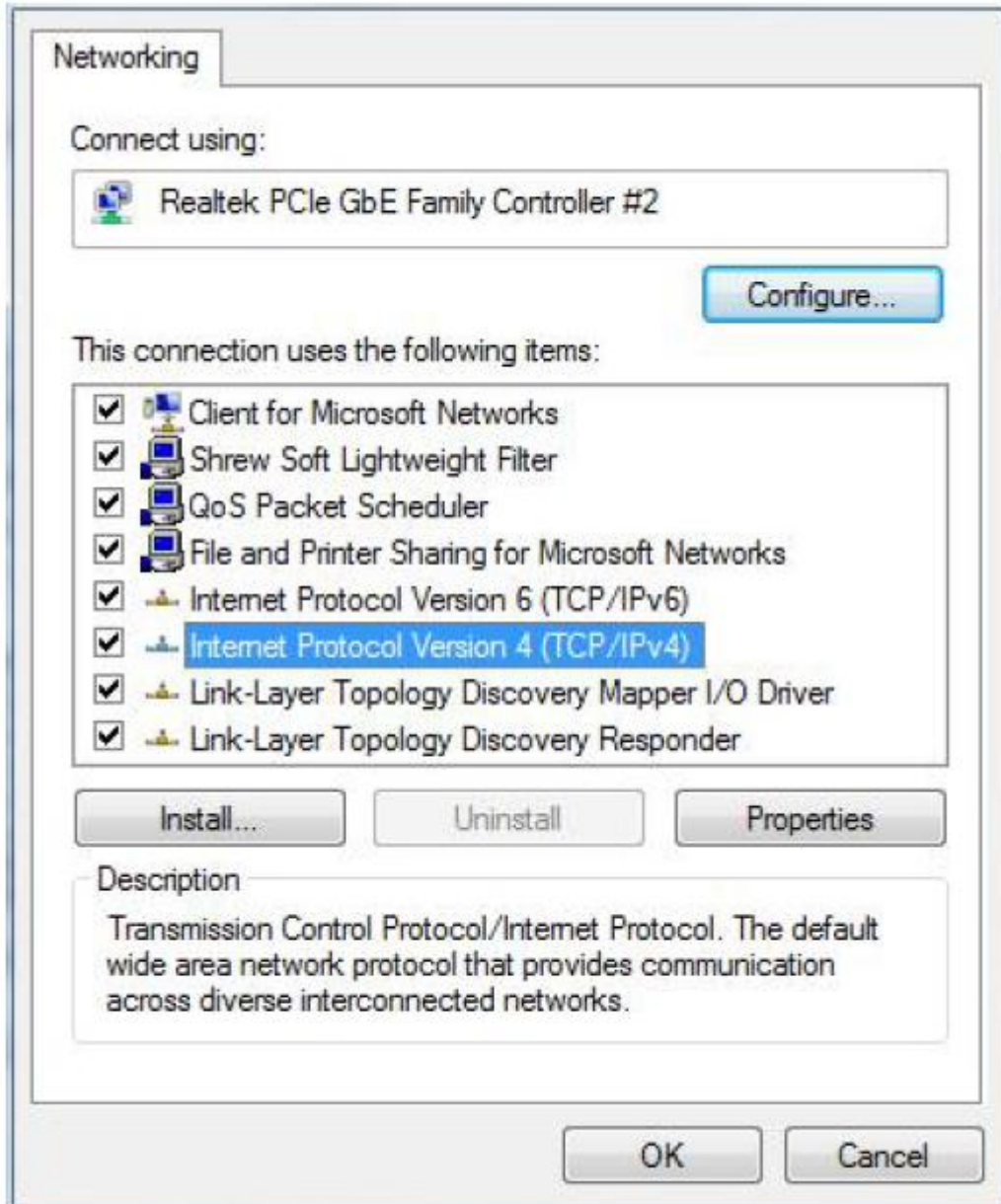

4. Two ways to configure the IP address:

Obtain an IP address automatically from the DHCP server and click "Obtain an IP address automatically";

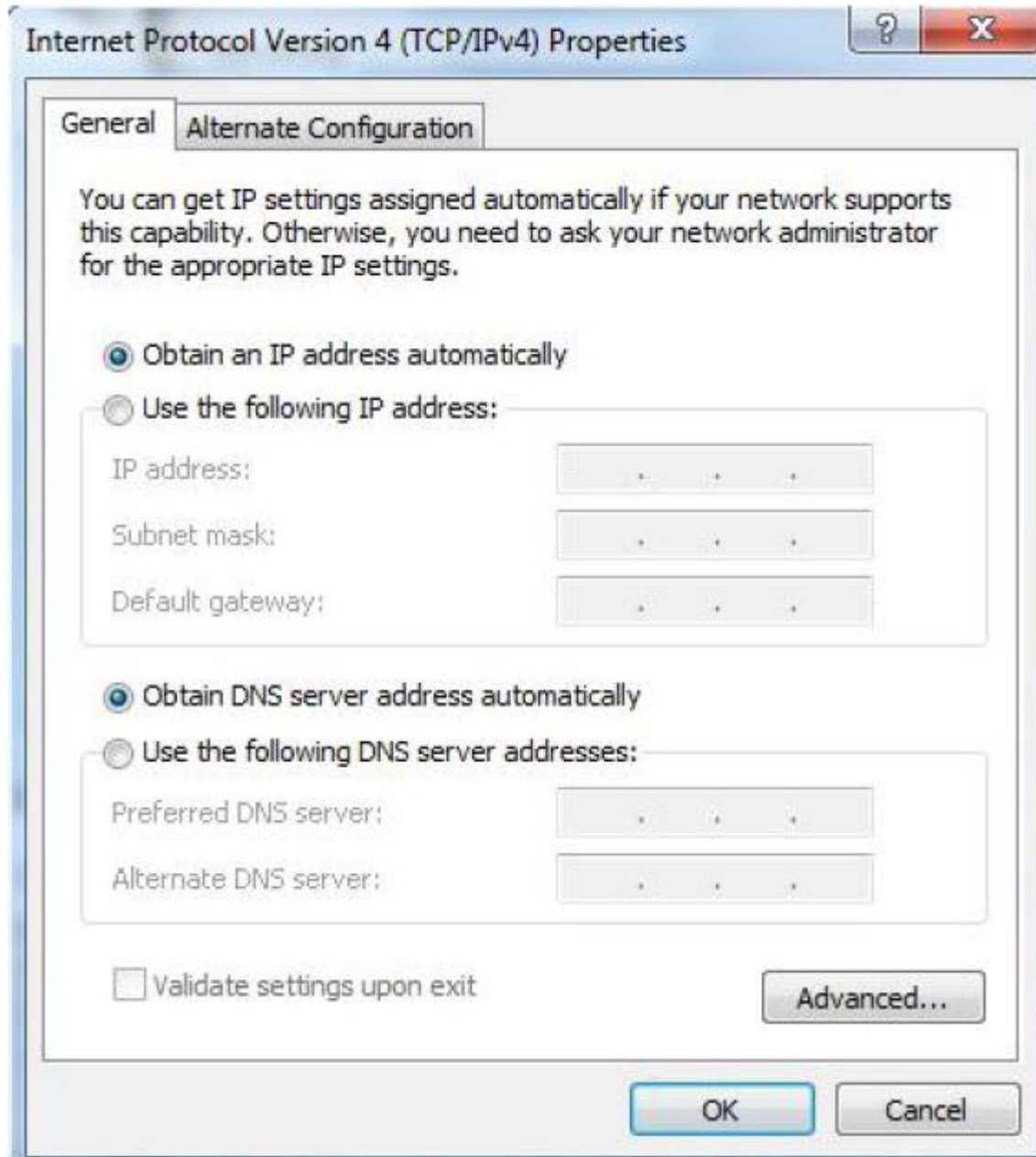

Manually configure the PC with a static IP address on the same subnet as the router address, click and configure "Use the following IP address".

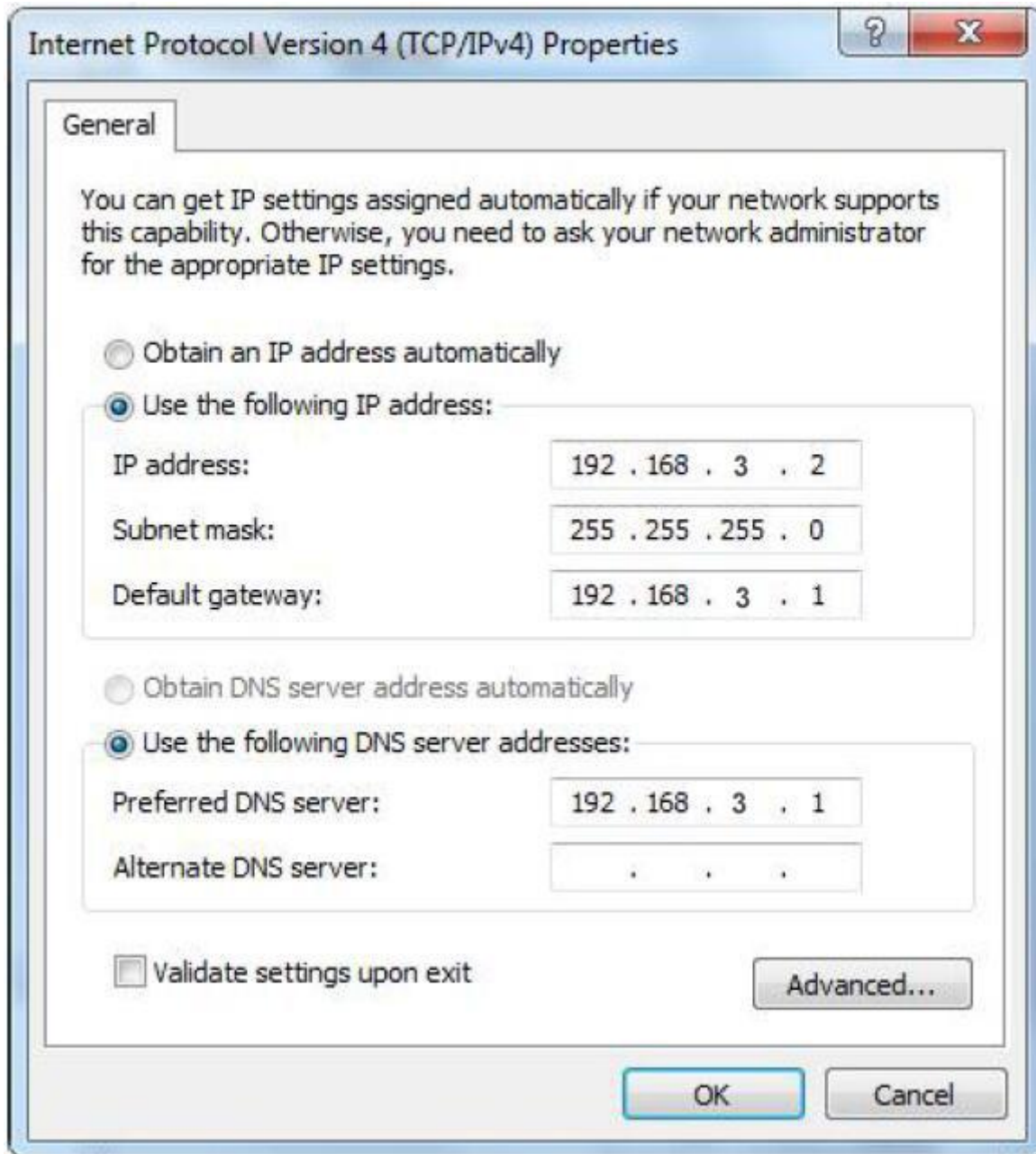

5. Click "OK" to complete the configuration.

4.2 Wifi Connection

Step1: Search wireless network: The network name default is King-xxxxxx, no password.



4G Wireless Industrial Router

Wireless Data Connectivity



Step2: Click “connect” to establish a connection.



4.3. Factory Default Settings

Before logging the configuration page, please check the default settings as below:

Item	Description
Login IP address	192.168.3.1
User name	admin
Password	none
DHCPserver	open
WIFI	SSID: King-xxxxxx KEY : No encryption (open network)

4.4. Enter Web Settings

- (1).Open a browser, such as IE, Google, etc. and enter IP address: <http://192.168.3.1>
- (2).Enter username and password, user name: admin Password: admin



4G Wireless Industrial Router

Wireless Data Connectivity

Sign in

http://192.168.3.1

Your connection to this site is not private

Username

Password

5. Router Settings

5.1 Status

R40B Overview - LuCI

Not secure | 192.168.3.1/cgi-bin/luci/

Apps 翻译 金蜂物联网云V3.0...

R40B Status System Services Network VPN Serial Port RTU I/O Logical operation Cloud platform Logout

Status

System

Hostname	R40B
Model	Mediatek MT7628AN evaluation board
Architecture	MediaTek MT7628AN ver:1 eco:2
Firmware Version	KingPigeon Technology Co., Ltd. v1.18
Kernel Version	4.14.162
Local Time	2020-10-23 05:02:05
Uptime	0h 5m 28s
Load Average	1.25, 1.10, 0.54

Memory

Total Available	63.86 MB / 121.79 MB (52%)
Free	74.29 MB / 121.79 MB (60%)
Buffered	5.55 MB / 121.79 MB (4%)
Cached	17.49 MB / 121.79 MB (14%)

In the status, it provides an overview, firewall, routing table, system log, kernel log, real-time information, etc., which is convenient for viewing the running status information of the router.



4G Wireless Industrial Router

Wireless Data Connectivity

5.2. System

5.2.1 System Properties

The screenshot shows the 'System Properties' configuration page for an R40B router. The page includes a navigation menu at the top with options like Status, System, Services, Network, VPN, Serial Port, RTU I/O, Logical operation, Cloud platform, and Logout. The main content area is titled 'System' and contains a sub-section 'System Properties' with tabs for 'General settings', 'Logging', 'Time Synchronization', 'Language and Style', and 'Product Type'. Under 'General settings', there are three main sections: 'Local Time' with a date/time input and 'Sync with browser'/'Sync with NTP-Server' buttons; 'Hostname' with a text input set to 'R40B' and a note 'Same as product Type(Cannot modify)'; and 'Timezone' with a dropdown menu set to 'UTC' and a note 'Please restart the router to take effect'. At the bottom right, there are 'Save & Apply', 'Save', and 'Reset' buttons. The footer indicates the page is powered by KingPigeon Technology Co., Ltd. (v1.18) / 2020-10-16.

Configure basic information , such as host name or time zone

System Properties		
Item	Description	
General setting	Local time	Set router time, can synchronize browser time or synchronize NTP server time
	Hostname	Default is the router model, cannot be modified
	Timezone	Please select your region
Logging	Log properties, it is not recommended to modify	
Time synchronization	Set NTP server for time synchronization	
Language and style	Language optional automatic (according to browser language changes, only recognize Chinese and English), Chinese, English;The theme cannot be modified.	
Product type	Product model, factory cured, cannot be modified	



4G Wireless Industrial Router Wireless Data Connectivity

5.2.2 Management Rights

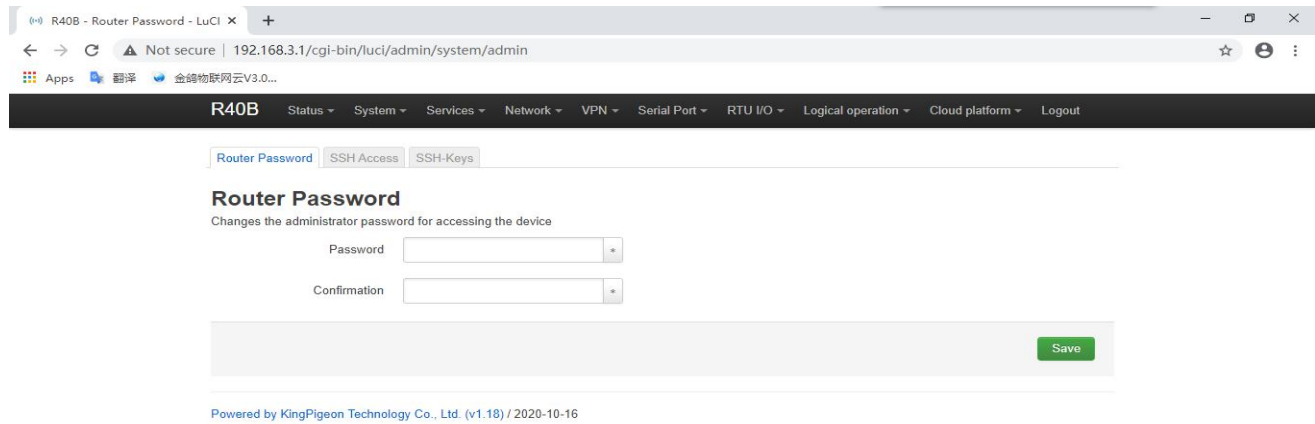

Management Rights	
Item	Description
Password	Change the administrator password to access the device
SSH access	Provides SSH access and SCP services
SSH keys	Compared with the use of ordinary passwords, the public key allows passwordless SSH login with higher security. To upload the new key to the device, paste the OpenSSH compatible public key line or drag the .pub file into the input field.

5.2.3 Software Package

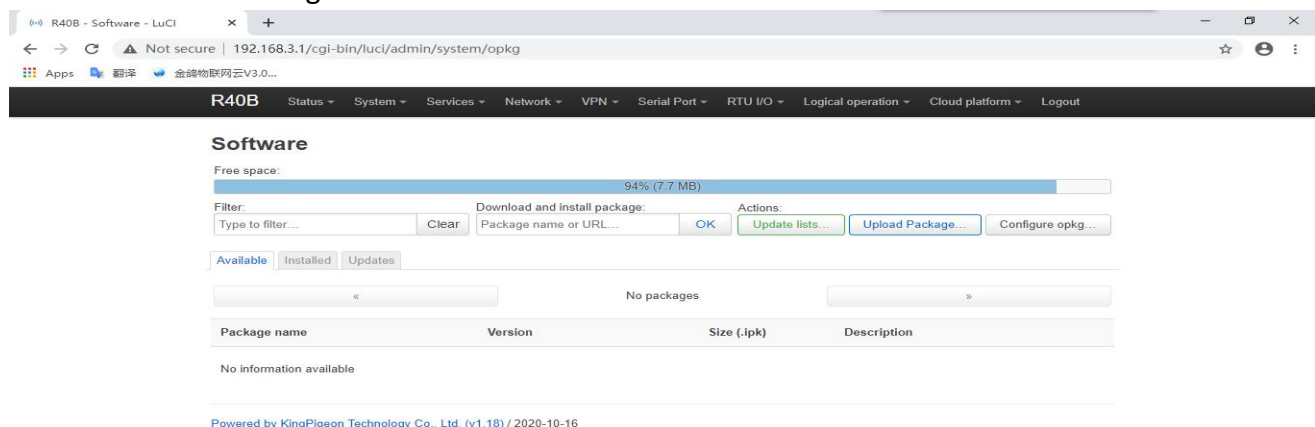

Software installation, clear, and upgrade. (Note: This function is for professionals!)



4G Wireless Industrial Router

Wireless Data Connectivity

5.2.4 Backup/Upgrade

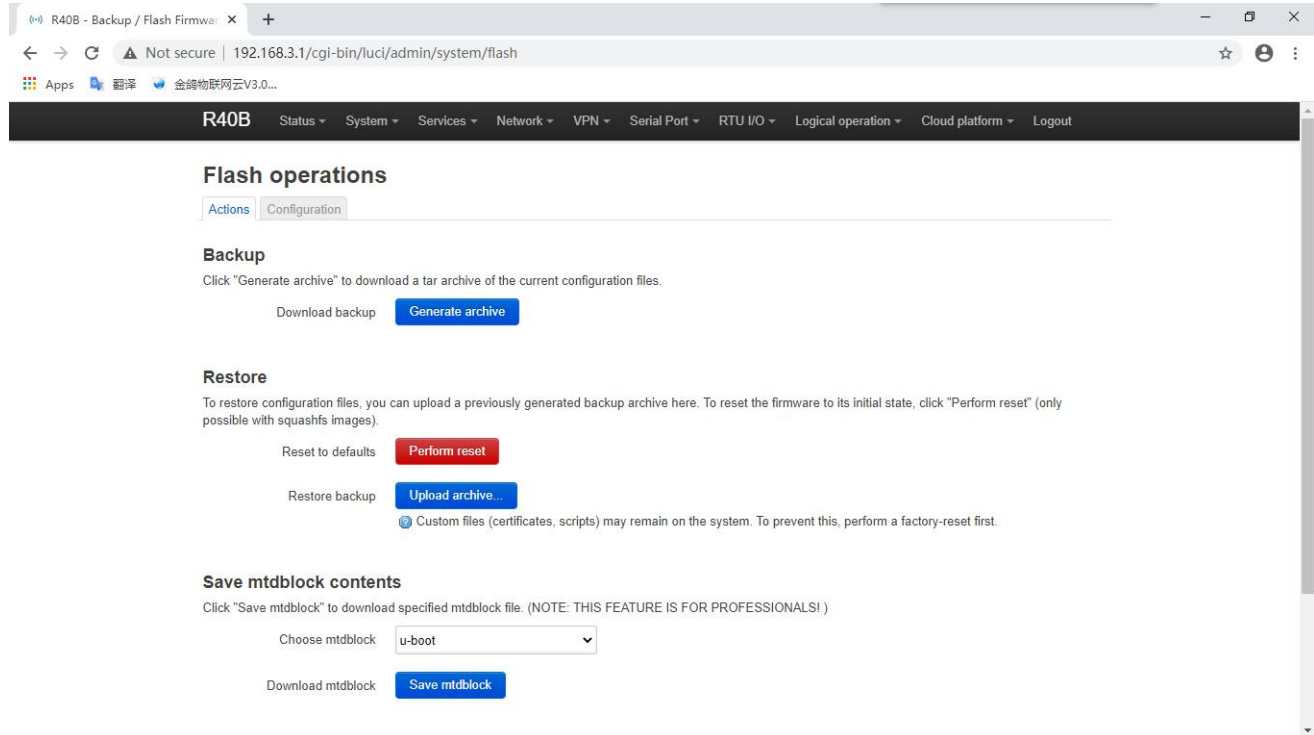

Backup/Upgrade	
Item	Description
Backup	Click "Generate Backup" to download the tar archive of the current configuration file.
Restore	Upload a backup archive to restore the configuration. To restore the firmware to its initial state, click "Perform Reset" (only squashfs format firmware is valid)
Save mtblock content	Click "Save mtblock" to download the specified mtblock file. (Note: This function is for professionals!)
Flash new firmware	Upload a sysupgrade compatible image from here to update the running firmware



4G Wireless Industrial Router Wireless Data Connectivity

5.2.5 Mount Point

Mount Point is used to connect external storage devices like USB drive, portable hard disk etc. Click Build Configuration and Mount the Connected Devices to show storage device partition in the system directory/mnt. For example, USB drive has 2 partitions sda1 and sda2. After mounting, the 2 partition information is shown in the system directory /mnt/sda1 and /mnt/sda2. Click Service-Network Sharing to share the directory for access through the shared directory.

Storage devices support NTFS, EXT4 and FAT32 formats. It must be partitioned and formatted before usage

R40B state system service The internet VPN application RTU I/O logic operation cloud platform quit

Mount point

Global Settings

Build configuration [Build configuration](#)
 Find all partitions and swap devices on the current system, and generate and replace existing configurations based on the search results

Mount the connected device [Mount the connected device](#)
 Try to enable the configured mount point for the connected device

Automatically mount unconfigured swap partitions
 Automatically mount swap partitions that are not specifically configured

Automatically mount unconfigured disk partitions
 Automatically mount partitions that are not specifically configured for mount points

Automatically mount swap
 Automatically mount swap partition through hotplug

Auto mount disk
 Mount the disk automatically via hotplug

Check the file system before mounting
 Automatically check for file system errors before mounting

Mounted file system

File system	Mount point	Available	used	Unmount partition
/dev/root	/rom	0 B / 8.50 MB	100.00% (8.50 MB)	-
tmpfs	/tmp	37.13 MB / 60.89 MB	39.03% (23.77 MB)	-
/dev/mtdblock6	/overlay	5.23 MB / 5.81 MB	9.95% (592.00 KB)	-
overlays:/overlay	/	5.23 MB / 5.81 MB	9.95% (592.00 KB)	-
tmpfs	/dev	512.00 KB / 512.00 KB	0.00% (0 B)	-

tmpfs	/tmp	37.13 MB / 60.89 MB	39.03% (23.77 MB)	-
/dev/mtdblock6	/overlay	5.23 MB / 5.81 MB	9.95% (592.00 KB)	-
overlays:/overlay	/	5.23 MB / 5.81 MB	9.95% (592.00 KB)	-
tmpfs	/dev	512.00 KB / 512.00 KB	0.00% (0 B)	-

Mount point

Configure the location and parameters of the storage device mounted to the file system

activated	equipment	Mount point	File system	Mount options	File system check	
<input type="checkbox"/>	UUID: e8f84077f8404652 (does not exist)	/mnt/sda1	auto	defaults	no	edit delete
<input type="checkbox"/>	UUID: eaf6-c246 (does not exist)	/mnt/sda4	auto	defaults	no	edit delete

[Add to](#)

Swap partition

If the physical memory is insufficient, idle data can be automatically moved to the swap area for temporary storage to increase the available RAM. Please note: Data processing in the swap area will be very slow, because the swap device cannot be accessed at a high rate like RAM.

activated	equipment
No configuration yet	

[Add to](#)

[Save and apply](#) [save](#) [Reset](#)

Provide secondary development use. (Note: This feature is for professionals!)



5.2.5 Reboot

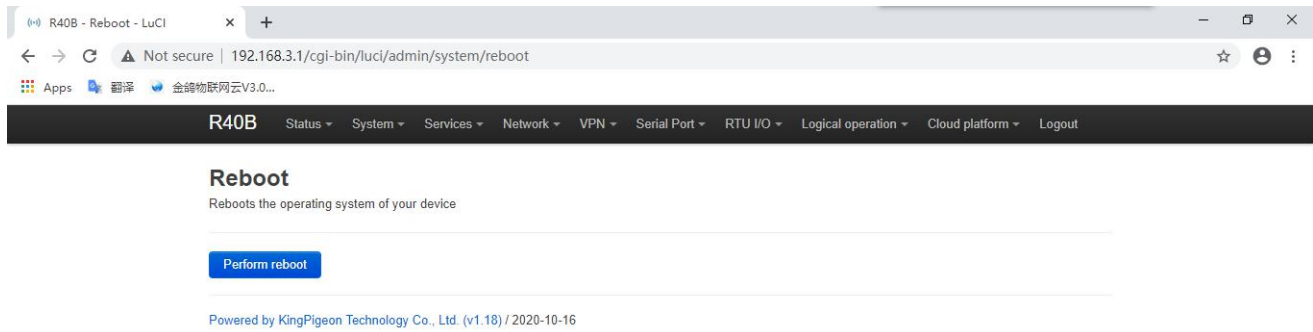

5.3. Service

5.3.1 Dynamic DNS

Dynamic DNS allows a fixed and accessible domain name to be configured for a host with a dynamic IP.

The overview displays a list of currently configured DDNS settings and their current status.

If you need to update the IPv4 and IPv6 addresses at the same time, you need to add two configuration items separately (for example, 'myddns_ipv4' and 'myddns_ipv6'). By default, IPv4 and IPv6 configurations have been added separately. Please click "Edit" to enter the modification of the DDNS service Detailed configuration.

Note: Before clicking "Add", you need to enter a name for identification, otherwise it cannot be added successfully.

5.3.1.1 Basic setting



4G Wireless Industrial Router

Wireless Data Connectivity

The screenshot shows the LuCI web interface for the R40B router. The page title is "Dynamic DNS" and the sub-page is "Details for: myddns_ipv4". The interface includes a navigation menu at the top with options like Status, System, Services, Network, VPN, Serial Port, RTU I/O, Logical operation, Cloud platform, and Logout. The main content area has tabs for "Basic Settings", "Advanced Settings", "Timer Settings", and "Log File Viewer". The "Basic Settings" tab is active, showing a form with the following fields and options:

- Enabled:
- Lookup Hostname:
- IP address version: IPv4-Address IPv6-Address
- DDNS Service provider [IPv4]:
- Domain:
- Username:

DNS Basic Settings	
Item	Description
enable	If the service configuration is disabled, then it cannot be started.
Lookup hostname	Hostname/FQDN verification, if IP update occurs or is necessary
IP address version	Set which IP address (IPv4 or IPv6) will be sent to the DDNS provider
DDNS service provider	Choose DDNS service provider
Domain	Enter domain name
Username	Enter username
Password	Enter password

5.3.1.2 Advanced Setting



4G Wireless Industrial Router

Wireless Data Connectivity

R40B Status System Services Network VPN Serial Port RTU I/O Logical operation Cloud platform Logout

Dynamic DNS

Dynamic DNS allows that your router can be reached with a fixed hostname while having a dynamically changing IP address.
 OpenWrt Wiki: [DDNS Client Documentation](#) --- [DDNS Client Configuration](#)

Details for: myddns_ipv4

Configure here the details for selected Dynamic DNS service.

Basic Settings **Advanced Settings** Timer Settings Log File Viewer

IP address source [IPv4]

Defines the source to read systems IPv4-Address from, that will be send to the DDNS provider

Network [IPv4]

Defines the network to read systems IPv4-Address from

Force IP Version

OPTIONAL: Force the usage of pure IPv4/IPv6 only communication.

DNS-Server

OPTIONAL: Use non-default DNS-Server to detect "Registered IP".
Format: IP or FQDN

PROXY-Server

OPTIONAL: Proxy-Server for detection and updates.

DNS Advanced Setting	
Item	Description
IP address source	Set the source of the IP address. This will be sent to the DDNS provider
Network	Read system IP address network
Force IP version	Optional: Force to use only IPv4/IPv6 communication.
DNS server	Optional: Use a non-default DNS server to detect "registered IP addresses". Format: IP or FQDN
Proxy server	Optional: Proxy server for detection and update. Format: [user:password@]proxyhost:port The IPv6 address must be filled in square brackets ("[]"): [2001:db8::1]:8080
Log to system log	Write the log to the system log. Regardless of whether this option is enabled, error messages will always be written to the system log.
Log to file	Write detailed information to the log. The file will automatically shrink.

5.3.1.3 Timer setting



4G Wireless Industrial Router Wireless Data Connectivity

R40B Status System Services Network VPN Serial Port RTU I/O Logical operation Cloud platform Logout

Dynamic DNS

Dynamic DNS allows that your router can be reached with a fixed hostname while having a dynamically changing IP address.
OpenWrt Wiki: [DDNS Client Documentation](#) --- [DDNS Client Configuration](#)

Details for: myddns_ipv4

Configure here the details for selected Dynamic DNS service.

Basic Settings Advanced Settings **Timer Settings** Log File Viewer

Check Interval
 Interval to check for changed IP
 Values below 5 minutes == 300 seconds are not supported

Force Interval
 Interval to force updates send to DDNS Provider
 Setting this parameter to 0 will force the script to only run once
 Values lower "Check Interval" except "0" are not supported

Error Retry Counter
 On Error the script will stop execution after given number of retrys
 The default setting of "0" will retry infinite.

Error Retry Interval
 On Error the script will retry the failed action after given time

Timmer Settings	
Item	Description
Check interval	Time interval for checking whether IP has changed Values less than 5 minutes (300 seconds) are not supported
Force interval	Mandatory time period to update DDNS to the provider Setting this parameter to 0 will make the script execute only once Values smaller than "check time period" are not supported (except 0)
Error retry counter	When an error occurs, the script will retry the number of times before exiting The default setting "0" will retry indefinitely.
Error retry interval	When an error occurs, the script will retry the number of failed actions

5.3.1.4 Log File Viewer



4G Wireless Industrial Router Wireless Data Connectivity

R40B - LuCI

Not secure | 192.168.3.1/cgi-bin/luci/admin/services/ddns/detail/myddns_ipv4

R40B Status System Services Network VPN Serial Port RTU I/O Logical operation Cloud platform Logout

Dynamic DNS

Dynamic DNS allows that your router can be reached with a fixed hostname while having a dynamically changing IP address.
OpenWrt Wiki: DDNS Client Documentation --- DDNS Client Configuration

Details for: myddns_ipv4

Configure here the details for selected Dynamic DNS service.

Basic Settings Advanced Settings Timer Settings Log File Viewer

Read / Reread log file

```

031306 : *****
031306 note : PID '3086' started at 2020-11-02 03:13
031306 : ddns version : 2.7.8-12
031306 : uci configuration:
ddns.myddns_ipv4.domain='yourhost.example.com'
ddns.myddns_ipv4.enabled='0'
ddns.myddns_ipv4.interface='wan'
ddns.myddns_ipv4.ip_network='wan'
ddns.myddns_ipv4.ip_source='network'
ddns.myddns_ipv4.lookup_host='yourhost.example.com'
ddns.myddns_ipv4.password='****pw****'
ddns.myddns_ipv4.service_name='dyn.com'
ddns.myddns_ipv4.username='your_username'
ddns.myddns_ipv4=service
031307 : verbose mode : 0 - run normal, NO console output
031307 WARN : Service section disabled! - TERMINATE
031307 WARN : PID '3086' exit WITH ERROR '1' at 2020-11-02 03:13

```

5.3.2 Network Sharing

If external storage device is connected to R40 USB port, online computer can access the storage device from the network shared directory. Click Interface to select access router through WAN or LAN. The directory is the same one/mnt set through System-Mount Point. The name is shared directory with computer access.

R40B state system service The internet VPN application RTU I/O logic operation cloud platform quit

network sharing

Smbd: 3.0.1 Kmod: 3.0.1

basic settings Edit template

interface
 Only monitor the specified interface, if not specified, monitor the lan

work group

describe

Shared directory

Please add a directory to be shared. Each directory refers to a folder on the mounted device.

name	contents→	Browsable	Read only	Force Root	Allow users	Allow anonymous users	Inherited owner	Hide dot files	Create permission mask	Directory permission mask	
<input type="text"/>	<input type="text"/>	<input checked="" type="checkbox"/>	<input type="checkbox"/>	<input type="checkbox"/>	<input type="text"/>	<input checked="" type="checkbox"/>	<input type="checkbox"/>	<input checked="" type="checkbox"/>	<input type="text" value="0666"/>	<input type="text" value="0777"/>	<input type="button" value="delete"/>

Powered by KingPigeon Technology Co., Ltd. (v1.20.10) / 2021-09-09



4G Wireless Industrial Router

Wireless Data Connectivity



5.4 Network

5.4.1 Interface

You can restart, close, edit, and delete existing interfaces, or add new interfaces. Default has LAN, WAN, WAN6, 4G and other interface configurations. Click "Edit" to enter the detailed configuration modification.

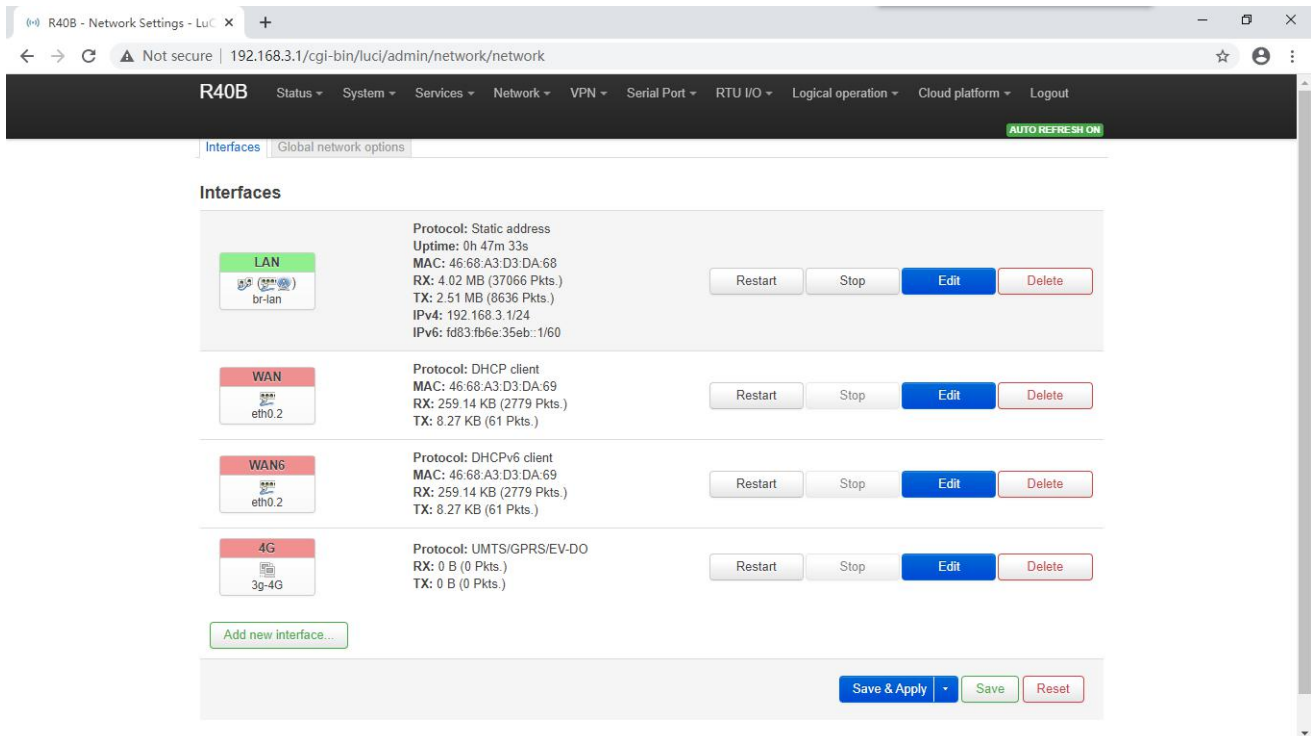

5.4.1.1 LAN port



4G Wireless Industrial Router

Wireless Data Connectivity

R40B - Network Settings - LuCI

192.168.3.1/cgi-bin/luci/admin/network/network

R40B Status System Services Network VPN Serial Port RTU I/O Logical operation Cloud platform Logout

Interfaces » LAN

General settings Advanced Settings Physical Settings Firewall Settings DHCP Server

Status **Device: br-lan**
 Uptime: 0h 48m 4s
 MAC: 46:68:A3:D3:DA:68
 RX: 4.06 MB (37443 Pkts.)
 TX: 2.67 MB (8883 Pkts.)
 IPv4: 192.168.3.1/24
 IPv6: fd83:fb6e:35eb::1/60

Protocol: Static address

Bring up on boot:

IPv4 address: 192.168.3.1

IPv4 netmask: 255.255.255.0

IPv4 gateway:

IPv4 broadcast: 192.168.3.255

Use custom DNS servers:

IPv6 assignment length: 60

Assign a part of given length of every public IPv6-prefix to this interface

LAN Port		
Item	Description	
Basic Setting	Status	Device: br-lan Running time: 8h 57m 16s MAC: E2:2F:C4:54:93:BA Receive: 18.81 MB (149126 data pack) Send: 99.87 MB (132321 data pack) IPv4: 192.168.3.1/24 IPv6: fdb2:428b:ddbe::1/60
	Protocol	Static address
	Bring up on boot	Default enable
	IPv4 address	Default 192.168.3.1, modify this setting to change the network segment that DHCP assigns IP to LAN port
	IPv4 netmask	Default 255.255.255.0
	IPv4 gateway	Default is empty, when multiple IPv4 addresses are set, the gateway address needs to be specified
	IPv4 broadcast	Default 192.168.3.255
	Use custom DNS server	Default is empty
	IPv6 allocation length	Assign a given length part of each public IPv6 prefix to this interface, default 60
	IPv6 assignment tips	Assign this hexadecimal sub-ID prefix to this interface
IPv6 suffix	Optional, allowed values: "eui64",	



4G Wireless Industrial Router

Wireless Data Connectivity

			"random" and other fixed values (for example: "::1" or "::1:2"). When the IPv6 prefix (such as "a:b:c:d::") is obtained from the authorization server, use the suffix (such as "::1") to synthesize an IPv6 address ("a:b:c:d::1") Assigned to this interface.
Advanced settings	Use built-in IPv6 management		Default enable
	Mandatory link		Regardless of the link status of the interface, always use the application settings (if checked, the link status change will no longer trigger hotplug event processing). default is enable.
	Reset MAC address		Modify MAC address
	Reset MTU		Default 1500
	Use Gateway Hop		Default 0
Physical settings	Bridge interface		Create a bridge for the specified interface, default is enable.
	Enable STP		Enable spanning tree protocol on this bridge, default is disable.
	Enable IGMP sniffing		Enable IGMP snooping on this bridge,default is disable
	Interface		Switch VLAN: "eth0.1" (lan), wireless network: Master "King-xxxxxx" (lan), set the physical interface using the LAN port, generally do not need to be modified
Firewall settings	Create/Assign firewall zone		Assign the firewall area to which this interface belongs, select Unspecified to move the interface out of the associated area, or fill in the creation field to create a new area and associate the current interface with it.
DHCP server	Basic Setting	Ignore this interface	DHCP service is not provided on this interface,default is disable
		Start	Start network address,default is 100.
		Customers	Maximum number of address assignments. The default is 150.
		Lease term	The expiration time of the leased address is at least 2 minutes (2m). The default is 12h.
	Advanced settings	DHCP	Provide DHCP service for all clients. If disabled, only customers with static leases will be served. default is enable.
		Forcibly	Even if another server is detected, it is



4G Wireless Industrial Router

Wireless Data Connectivity

			mandatory to use DHCP on this network, default is disable.
		IPv4 Subnet mask	Reset the subnet mask sent to the client.
IPv6 setting		DHCP Options	Set additional options for DHCP, for example, setting "6,192.168.2.1,192.168.2.2" means to announce different DNS servers to clients.
		Route Advertisement Service	Default server mode
		DHCPv6 server	Default server mode
		HDP proxy	Default disable
		DHCPv6 mode	The default is stateless + stateful
		Always advertise the default route	Even if there is no public network prefix available, it still advertises itself as the default route, default is disable
		Advertised DNS server	Default is empty
Advertised DNS domain name	Default is empty		

5.4.1.2 WAN port

The screenshot shows the 'Interfaces » WAN' configuration page. The 'General settings' tab is selected. The status for the interface 'eth0.2' is shown as 'Device: eth0.2, MAC: 46:68:A3:D3:DA:69, RX: 259.14 KB (2779 Pkts.), TX: 8.27 KB (61 Pkts.)'. The protocol is set to 'DHCP client'. The 'Bring up on boot' checkbox is checked. The hostname to send when requesting DHCP is 'R40B'. Below this, a 4G interface is listed with the protocol 'UMTS/GPRS/EV-DO' and an error message: 'Error: Network device is not present'. Buttons for 'Dismiss', 'Save', 'Restart', 'Stop', 'Edit', and 'Delete' are visible.

WAN Port	
Item	Description



4G Wireless Industrial Router

Wireless Data Connectivity

General Setting	Status	Device: eth0.2 Running time: 9h 37m 16s MAC: E2:2F:C4:54:93:BB Receive: 113.65 MB (290226 data pack) Send: 19.02 MB (137282 data pack) IPv4: 192.168.1.173/24
	Protocol	Default DHCP client; if the network connected to the WAN requires an account and password to log in, please select PPPoE protocol or other corresponding protocol
	Bring up on boot	Default is enable
	Hostname sent when requesting DHCP	Default is product model
Advanced settings	Use built-in IPv6 management	Default is enable
	Mandatory link	Regardless of the link status of the interface, always use the application settings (if checked, the link status change will no longer trigger hotplug event processing). Default is disable.
	Use broadcast tags	Needed by some ISPs, for example: coaxial network DOCSIS 3,default is disable.
	Default gateway	Leave blank to not configure the default route, default is enable.
	Obtain DNS server automatically	Leave blank to ignore the advertised DNS server address,default is enable.
	Use Gateway Hop	Default is empty
	Client ID sent when requesting DHCP	Default is empty
	Vendor Class option sent when requesting DHCP	Default is empty
	Reset MAC address	Modify MAC address
	Reset MTU	Default is 1500
Physical settings	Bridge interface	Create a bridge for the specified interface,default is disable
	Interface	Switch VLAN: "eth0.2" (wan, wan6), set which physical interface to use, generally do not need to be modified
Firewall settings	Create/Assign firewall zone	Assign the firewall area to which this interface belongs, select Unspecified to move the interface out of the associated area, or fill in the creation field to create a new area and associate the current interface with it.



4G Wireless Industrial Router

Wireless Data Connectivity

5.4.1.3 WAN6 Port

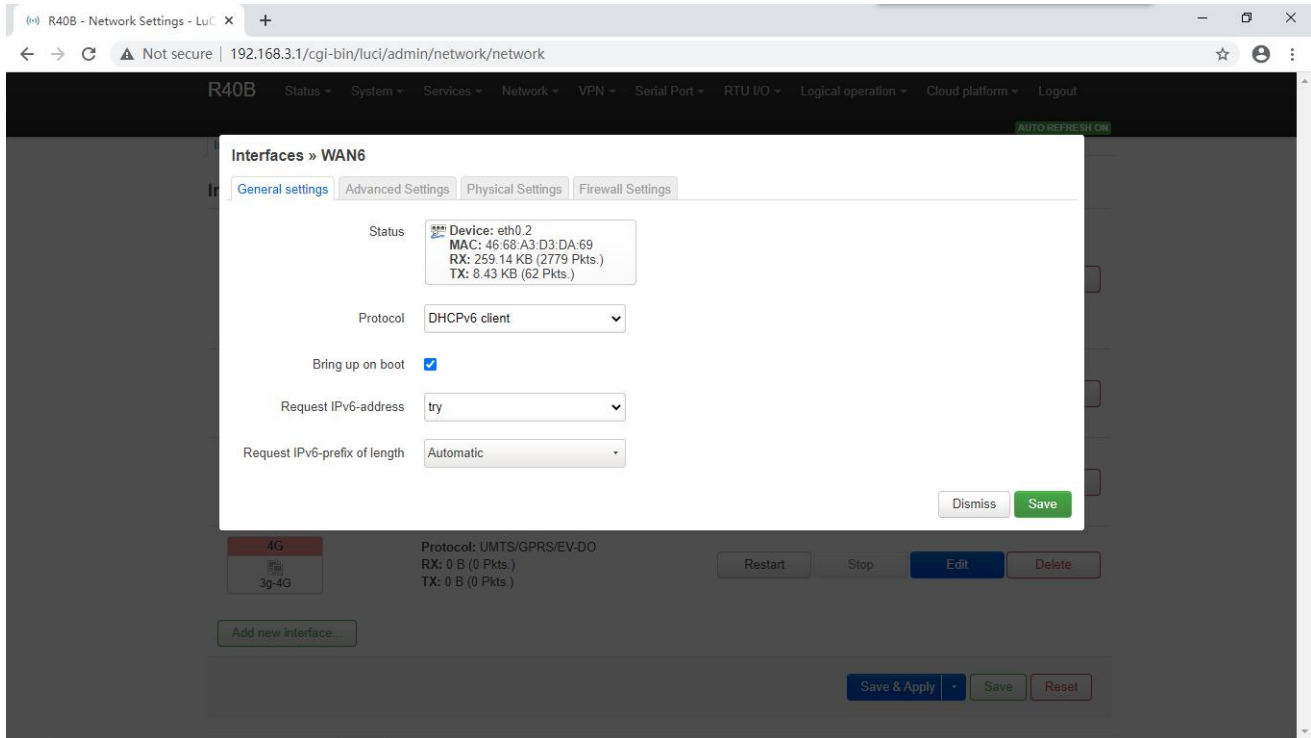

WAN6		
Item	Description	
Basic Setting	Status	Device: eth0.2 MAC: E2:2F:C4:54:93:BB Receive: 115.31 MB (299495 data pack) Send: 19.41 MB (140798 data pack)
	Protocol	Default DHCPv6 client
	Bring up on boot	Default is enable
	Request IPv6 address	Default is try
	Request IPv6 prefix of length	Default automatic
Advanced settings	Use built-in IPv6 management	Default enable
	Mandatory link	Regardless of the link status of the interface, always use the application settings (if checked, the link status change will no longer trigger hotplug event processing). Default is disable.
	Use default gateway	Leave blank to not configure the default route
	Custom assigned IPv6 prefix	Default is empty
	Obtain DNS server automatically	Leave blank to ignore the advertised DNS server address, default is enable.
	Client ID sent when requesting	Default is empty



4G Wireless Industrial Router

Wireless Data Connectivity

	DHCP	
	Reset MAC address	Modify MAC address
	Reset MTU	Default 1500
Physical settings	Bridge interface	Create a bridge for the specified interface, default is disable.
	Interface	Switch VLAN:"eth0.2"(wan,wan6)
Firewall settings	Create/Assign firewall zone	Assign the firewall area to which this interface belongs, select Unspecified to move the interface out of the associated area, or fill in the creation field to create a new area and associate the current interface with it.

5.4.1.4 4G Port

4G		
Item		Description
Basic Setting	Status	Device: 3g-4G Running time: 0h 11m 52s Receive: 1.06 KB (18 data pack) 发送: 8.50 KB (36 data pack) IPv4: 10.94.92.16/32
	Protocol	UMTS/GPRS/EV-DO
	Bring up on boot	Default is enable
	Modem equipment	Default/dev/ttyUSB4
	Service type	Default UMTS/GPRS
	APN	SIM Card Internet access point
	PIN	SIM card PIN code
	PAP/CHAP uername	User name for PPP authentication



4G Wireless Industrial Router

Wireless Data Connectivity

	PAP/CHAP password	Password for PPP authentication
	Dial number	SIM Card Internet dialing
Advanced settings	Use built-in IPv6 management	Default is enable
	Mandatory link	Regardless of the link status of the interface, always use the application settings (if checked, the link status change will no longer trigger hotplug event processing), Default is disable.
	Obtain IPv6 address	Default auto
	Modem initialization timeout	The maximum waiting time for the modem to be ready (seconds), default 10
	Use default gateway	Leave blank to not configure the default route, default is enable.
	Use Gateway Hop	Default is empty
	Obtain DNS server automatically	Leave blank to ignore the advertised DNS server address,default is enable.
	LCP Response failure threshold	After the specified number of LCPs respond to the fault, it is assumed that the link has been disconnected. 0 means ignore the fault, and the default is 0.
	LCP Response interval	LCP response is sent regularly (seconds), which is only valid when the fault threshold is combined, the default is 5
	Activity timeout	Close the inactive link after a given time (seconds), 0 is to keep the connection, the default is 0
Firewall settings	Create/Assign firewall zone	Assign the firewall area to which this interface belongs, select Unspecified to move the interface out of the associated area, or fill in the creation field to create a new area and associate the current interface with it.

5.4.1.5 WAN/LAN Switch

If WAN is not used, tick Switch Wan port o LAN port and click Save and Apply



4G Wireless Industrial Router

Wireless Data Connectivity

LAN/WAN switch

Switch WAN port to LAN port

Mandatory application Save and apply Mandatory application

save Reset

Powered by KingPigeon Technology Co., Ltd. (v1.20.10) / 2021-09-09

To switch from WAN to LAN, you must click Force Apply and save

5.4.2 WIFI

WiFi Settings

radio0 Media Tek MT76x8 802.11bgn Channel: 11 (2.462 GHz) | Bitrate: ? Mbit/s Restart Scan Add

0% SSID: King-2b77b3 | Mode: Master BSSID: EC:0C:45:81:26:51 | Encryption: None Disable Edit Remove

Associated Stations

Network	MAC-Address	Host	Signal / Noise	RX Rate / TX Rate
No information available				

Save & Apply Save Reset

Powered by KingPigeon Technology Co., Ltd. (v1.18) / 2020-10-16

Supports both WLAN hotspot and WLAN client.

The wireless overview shows the current wireless status, you can click Edit to enter the detailed configuration, or restart, scan, add, disable, remove, etc.

Connected stations shows the currently connected wireless stations, which can be disconnected.

5.4.2.1 WLAN Hotspot(Wifi AP mode)



4G Wireless Industrial Router

Wireless Data Connectivity

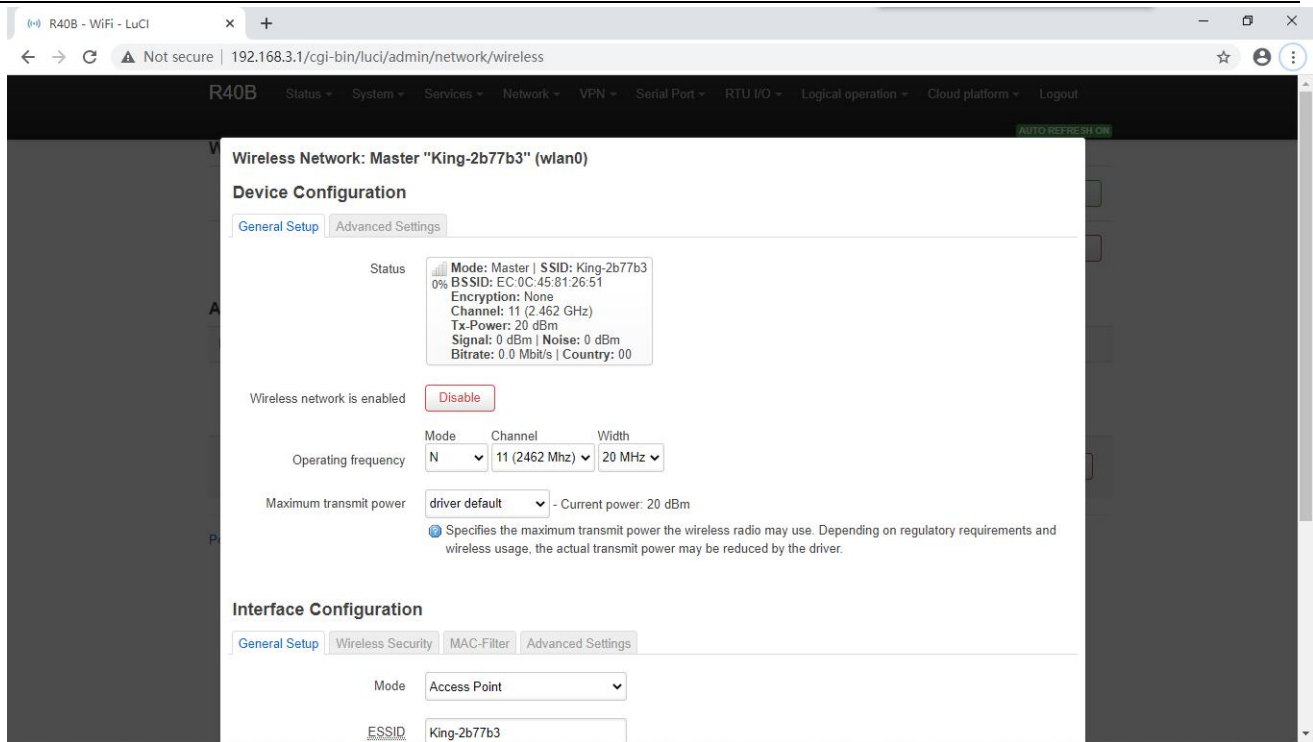

The default SSID is King-xxxxxx, no encryption method, other clients can directly search the wireless network to connect to this hotspot.

Quick configuration: Select the wireless configuration in Master mode in the wireless profile, click "Edit" to enter the configuration page, find "Interface Configuration"- "Basic Settings"- "ESSID" to modify the WiFi hotspot name, find "Interface Configuration" - "Wireless Security"- "Encryption" can modify the encryption method to set the WiFi password.

Note: When using WiFi connection to enter the router configuration, to modify the WLAN hotspot configuration, you need to select "force application", please click the drop-down button behind "save and apply" and select "force application"

Wireless network AP hotspot device configuration		
Item	Description	
General Setup	 97% Mode: Master SSID: King-ff4a8a BSSID: EE:0C:45:81:26:51 Encryption: None Channel: 6 (2.437 GHz) Transmission power: 20 dBm Signal: -42 dBm Noise: 0 dBm Transmission rate: 58.5 Mbit/s Country: 00	
	Wireless network is enabled	Default is enable
	Operating frequency	If there are too many devices in use at the current frequency, please change one
	Maximum transmit	Specify the maximum transmit power.



4G Wireless Industrial Router

Wireless Data Connectivity

	power	Depending on regulatory requirements and usage, the driver may limit the actual transmit power below this value.
Advanced settings	Country code	Driver default
	Allow traditional 802.11b rate	Default is enable
	Distance optimization	The distance (meter) of the furthest network user. Automatic by default, automatically adjust the transmission power according to the distance
	Fragmentation threshold	Automatically send data when the data length exceeds the threshold, generally use the default value
	RTS/CTS Threshold	Request to send/allow sending protocol. When the data length exceeds the threshold, start the protocol to avoid signal conflicts caused by multiple terminals sending data to the AP. Usually use default value
	Force 40MHz mode	Even if the auxiliary channels overlap, the 40MHz channel is always used. Using this option is not compliant with IEEE 802.11n-2009! Default is disable.
	Beacon interval	Indicates the interval at which the wireless router periodically broadcasts its SSID. Usually use default value.

Wireless network AP hotspot interface configuration		
Item		Description
Basic Setting	Mode	Access Point
	ESSID	Default King-xxxxxx (xxxxxx is Random numbers or letters)
	Network	lan
	Hide ESSID	Default is disable
	WMM mode	Wi-Fi Multimedia, providing different priorities for different services to ensure service quality, default is enable
Wireless security	encryption	No encryption by default (open network)
MAC filter	MAC address filter	Default is disable
Advanced settings	Isolate the client	Forbid communication between clients, default is disable
	Interface name	Reset the default interface name
	Short Preamble	Different rates need to use different Preamble (preamble), default is enable
	DTIM interval	As a terminal node, periodically wake up to send traffic indication message interval
	Interval for	Temporary key (GTK), Use default



4G Wireless Industrial Router

Wireless Data Connectivity

	re-encrypting GTK	
	Disable inactive polling	Default is disable
	Inactive site restrictions	Default is empty
	Max allowed listening interval	Default is empty
	Disconnect on low Ack response	Allow AP mode to disconnect wireless terminal under low ACK,default is enable.

5.4.2.2 WLAN Client

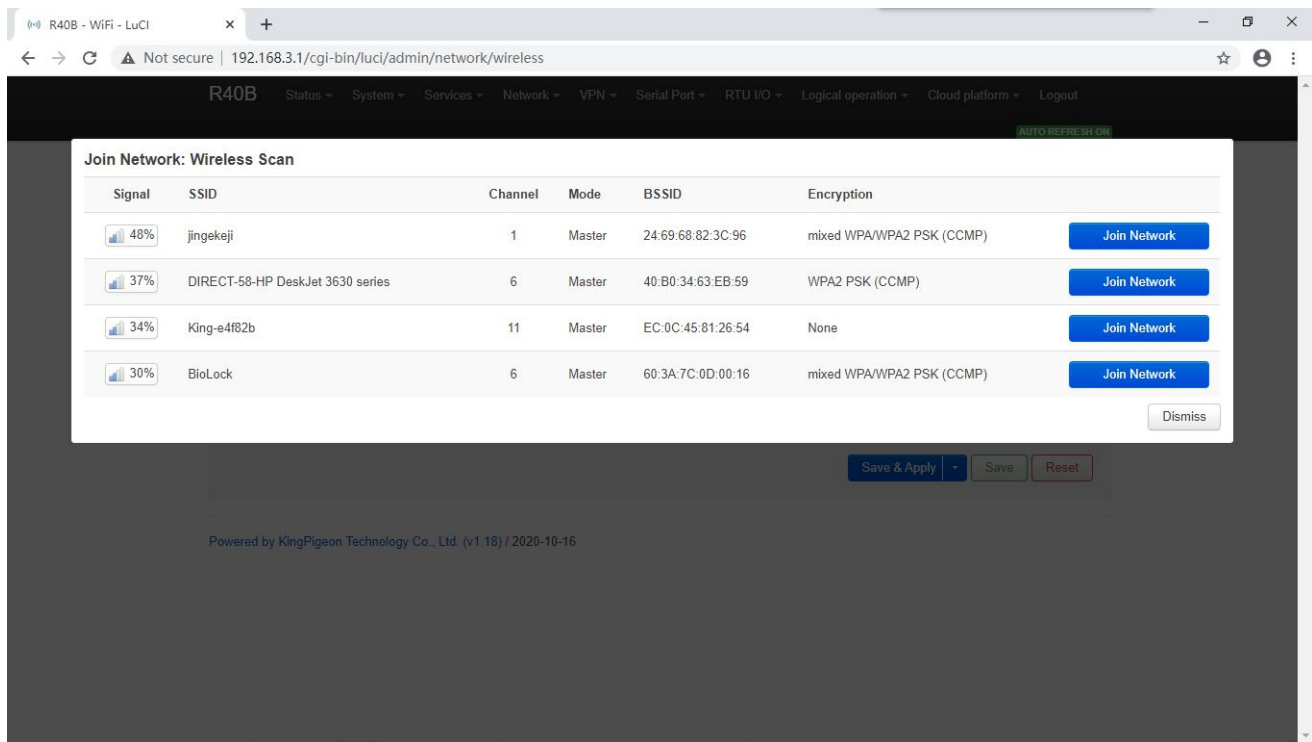

Please click "Scan" to search the wireless network, select "Join Network" to enter the quick configuration page, if a password is required, enter the WiFi password in "WPA Key", then click "Submit" to enter the detailed configuration page, and finally click "Save" .

Device Configuration		
Item	Description	
Basic Setting	Status	100% Mode: Client SSID: jingekeji BSSID: EC:0C:45:81:26:51 Encryption: WPA2 PSK (CCMP) Channel: 6 (2.437 GHz) Transmission power: 20 dBm Signal: -38 dBm Noise: 0 dBm Transmission rate: 1.0 Mbit/s Country: 00
	Wireless network is enabled	Default is enable



4G Wireless Industrial Router

Wireless Data Connectivity

	Working frequency	If there are too many devices in use at the current frequency, please change one
	Max transmission power	Specify the maximum transmit power. Depending on regulatory requirements and usage, the driver may limit the actual transmit power below this value.
Advanced settings	Country code	Driver default
	Allow traditional 802.11b rate	Default is enable
	Distance optimization	The distance (meter) of the furthest network user. By default, the transmission power is automatically adjusted according to the distance
	Fragmentation threshold	Automatically send data when the data length exceeds the threshold, usually use default value.
	RTS/CTS Threshold	Request to send/allow to send protocol. When the data length exceeds the threshold, start the protocol to avoid signal collision caused by multiple terminals sending data to the AP, usually use default value.
	Force 40MHz mode	Even if the auxiliary channels overlap, the 40MHz channel is always used. Using this option is not compliant with IEEE 802.11n-2009! default is disable.
	Beacon interval	Indicates the interval at which the wireless router periodically broadcasts its SSID, usually use default value.

Interface configuration		
Item	Description	
Basic Setting	Mode	Client
	ESSID	Wireless network name
	BSSID	none
	Network	Wwan, no need modify it
Wireless security	Encryption	WPA2-PSK (Strong security)
	Algorithm	auto
	Password	Wireless network password
	802.11w Management Frame Protection	Requires the full version of wpa2/hostapd, and WiFi driver support, default is disabled
	Interface name	Reset the default interface name
	Short Preamble	Different rates require different Preambl (preamble), default is enable
	DTIM interval	As a terminal node, periodically wake up to send traffic indication message interval
	Re-encrypt GTK time interval	Temporary key (GTK) Use default value
	Disable inactive polling	Default is disable
Inactive site	Default is empty	



4G Wireless Industrial Router

Wireless Data Connectivity

	restrictions	
	Maximum allowed listening interval	Default is empty
	Disconnect on low Ack response	Allow AP mode to disconnect wireless terminal under low ACK,default is enable

5.4.3 Cellular Network

R40B state system service The internet VPN application RTU I/O logic operation cloud platform quit

Cellular network UNSAVED CONFIGURATION: 2

Cellular network

Enable cellular network

Registration status NA

Operator NA

Signal strength NA
Signal value normal range 14-31

Firmware version NA

IMSI NA

IMEI NA

SIM card ID NA

Choose a calling card Card 2

Card 2 number

Card 2 APN

Card 2 username

Card 2 password

Enable GPS

SIM card switch automatically

Automatic network switching

Cellular Network	
Item	Description
Register status	Registered
Operator	N/A
Signal	Normally is 14-31
Firmware version	EC25AUGCR06A02M1G
IMSI	SIM card IMSI number
IMEI	Device IMEI number
SIM card ID	SIM card ICCID number
Card select	Card 1, Card 2, this selection as the preferred SIM card, When the preferred SIM card cannot be connected to the network, it will automatically switch to another card to try to connect to the network
Card 1 /2 number	Enter sim card 1 number
SIM card 1/2 APN	Enter APN
SIM card 1/2 username	Enter username
SIM card 1/2 password	Enter password
Enable GPS	Default is disable,when choosing a module with GPS



4G Wireless Industrial Router

Wireless Data Connectivity

	function, please select enable, GPS data will be uploaded through MQTT protocol
Automatic network switching	Check to enable the function

5.4.4 DHCP/DNS

The screenshot shows the 'DHCP and DNS' configuration page. Under 'Server Settings', the 'Static Leases' tab is active. It contains a table with columns: Hostname, MAC-Address, IPv4-Address, Lease time, DUID, and IPv6-Suffix (hex). Below the table is an 'Add' button. There are also sections for 'Active DHCP Leases' and 'Active DHCPv6 Leases', both showing empty tables with a message 'There are no active leases'.

Dnsmasq provides an integrated DHCP server and DNS forwarder for the NAT firewall

Server Settings		
Item	Description	
General Setting	Ignore empty domain name resolution	Do not forward resolution requests without DNS names, checked by default
	Unique authorization	This is the only DHCP server in the local network, default is enable
	Local server	Local domain rules. Names matching this domain are never forwarded, only resolved from DHCP or HOSTS files
	Local domain name	The local domain name suffix will be added to the DHCP and HOSTS file entries
	Record query log	Write received DNS request to system log, default is disable
	DNS forward	List of DNS servers to which requests are forwarded
	Rebinding protection	Discard RFC1918 upstream response data, default is enable
	Allow local	Allow upstream response within 127.0.0.0/8 loopback range, for example: RBL service, default is enable.



4G Wireless Industrial Router

Wireless Data Connectivity

	Domain name whitelist	List of domain names that allow RFC1918 to respond
	Local service only	DNS service is only provided in the subnet to which the network card belongs,default is enable.
	Not all addresses	Dynamically bind to interface instead of wildcard address (recommended as linux default),default is enablee
	Listening interface	Only listen to these interfaces and loopback interfaces.
	Exclude interface	Do not listen to these interfaces.
HOSTS& parse the file	use /etc/ethers Configuration	Configure DHCP server according to /etc/ethers,default is enable.
	Lease documents	The file used to store the assigned DHCP lease,default is :/tmp/dhcp.leases
	Ignore parsing file	Default is disable
	Ignore /etc/hosts	Default is disable
	Additional HOSTS file	Default is empty
TFTP setting	Enable TFTP server	Default is disable
Advanced settings	No log	Does not record general operation logs of these protocols,default is disable.
	Sequential allocation IP	IP addresses are assigned sequentially starting from the lowest available address, default is disable.
	Filter local packages	Reverse queries without forwarding the local network,default is enable.
	Filter useless packets	Do not forward requests that the public domain name server cannot respond,default is disable
	Localized query	If multiple IPs are available, the host name is localized according to the subnet from which the request originated,default is enable
	Expand the host suffix in the HOSTS file	Add the local domain name suffix to the domain name in the HOSTS file,default is enable
	Disable invalid information cache	Do not cache useless responses, for example: domain names that do not exist,default is disable
	Additional SERVERS file	This file may contain formats such as "server=/domain/1.2.3.4" or "server=1.2.3.4".The former specifies a DNS server for a specific domain, while the latter does not limit the resolution range of the server.
	Strict order checking	Query DNS server in the order of "parse file",default is disable.
	All server	Query all available upstream DNS servers,default is disable.
	Ignore fake empty domain name	List of servers allowed to respond with fake empty domain names



4G Wireless Industrial Router

Wireless Data Connectivity

	resolution	
	DNS server port	Inbound DNS query port
	DNS query port	Specified DNS query source port
	Max DHCP leases No.	Maximum number of DHCP leases allowed
	Max EDNS0 data pack size	Allowed max EDNS.0 UDP data pack size
	Maximum concurrent queries number	Maximum number of concurrent DNS queries allowed
	DNS Query cache size	Cached DNS entries numbers (maximum 10000, 0 means no cache)
Static address assignment		<p>Static leases are used to assign fixed IP addresses and host IDs to DHCP clients. Only the specified host can be connected, and the interface must be non-dynamically configured.</p> <p>Use the Add button to add a new lease entry. The values of the IPv4 address and host name fields will be fixedly assigned to the hosts identified by the MAC address field. The lease period is an optional field, and the length of the DHCP lease period can be set separately for each host, for example: 12h, 3d, infinite, Respectively 12 hours, 3 days, permanent.</p>

5.4.5 Host names

The screenshot shows the LuCI web interface for the R40B router. The browser address bar shows the URL `192.168.3.1/cgi-bin/luci/admin/network/hosts`. The page title is "Hostnames". Under "Host entries", there is a table with two columns: "Hostname" and "IP address". The table is empty, and a message below it says "This section contains no values yet". There is an "Add" button below the table. At the bottom right, there are three buttons: "Save & Apply", "Save", and "Reset". The footer of the page reads "Powered by KingPigeon Technology Co., Ltd. (v1.18) / 2020-10-16".

After adding the host mapping, you can access the specified IP address by accessing the host name

5.4.6 Routes



4G Wireless Industrial Router

Wireless Data Connectivity

R40B - Static Routes - LuCI

Not secure | 192.168.3.1/cgi-bin/luci/admin/network/routes

R40B Status System Services Network VPN Serial Port RTU I/O Logical operation Cloud platform Logout

Routes

Routes specify over which interface and gateway a certain host or network can be reached.

Static IPv4 Routes Static IPv6 Routes

Static IPv4 Routes

Interface	Target	IPv4-Netmask	IPv4-Gateway	Metric	On-Link route
	Host-IP or Network	if target is a network			
This section contains no values yet					

Add

Save & Apply Save Reset

Powered by KingPigeon Technology Co., Ltd. (v1.18) / 2020-10-16

The routing table describes the reachable path of the packet

Routes		
Item		Description
Basic Setting	interface	Select setting interface
	Target	Host IP or network, requires valid IP or network
	IP Subnet mask	If the object is a network, a valid IP or network is required
	IP gateway	Need valid IP or network
Advanced settings	Hops	0
	MTU	1500
	Type	unicast
	Routing table	main(254)
	Source address	Auto
	On-Link Routing	Default is disable

5.4.7 Diagnosis



4G Wireless Industrial Router Wireless Data Connectivity

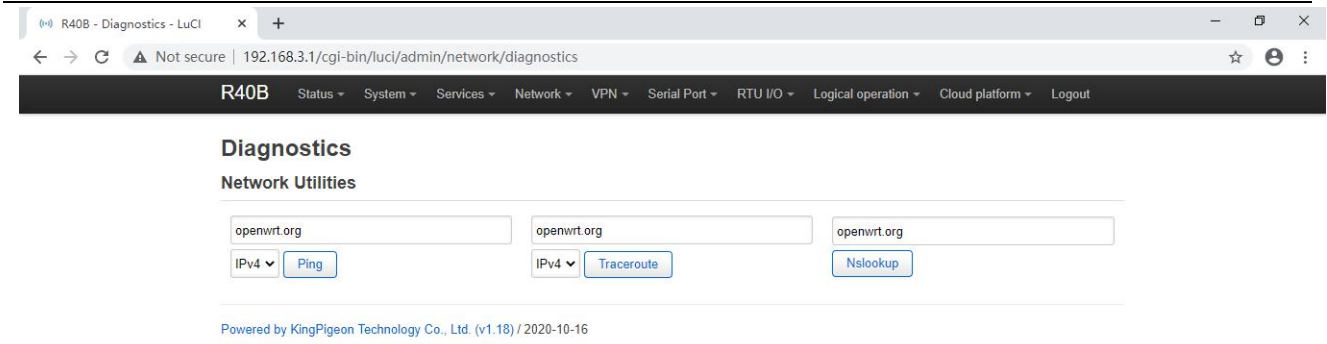

Three commands are provided here: Ping, Traceroute, and Nslookup, which can perform simple diagnosis on the network.

5.4.8 Firewall

5.4.8.1 Zone settings

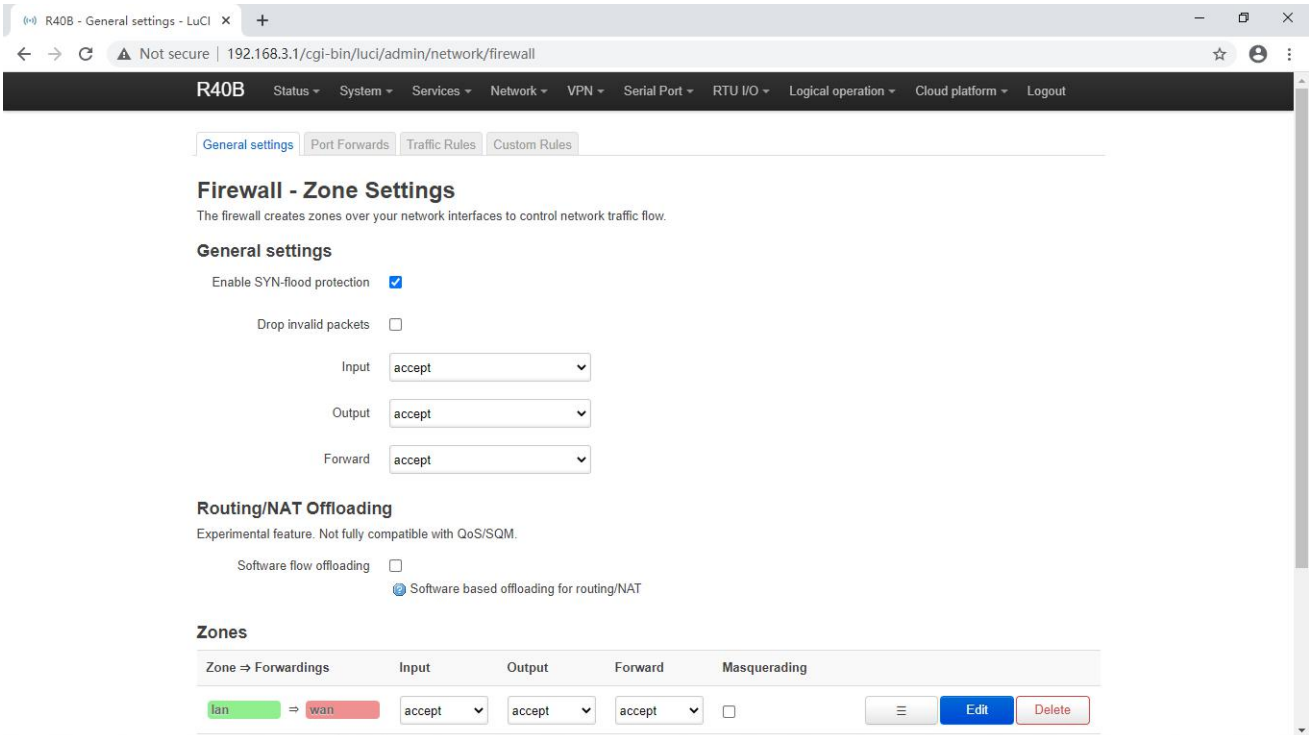

The firewall controls network traffic by creating zones on network interfaces.

Firewall-Zone Settings	
Item	Description
General	This section defines the general properties of "lan". The inbound data and



4G Wireless Industrial Router

Wireless Data Connectivity

Setting	outbound data options are used to set the default strategy for inbound and outbound traffic in this area, and the forwarding options describe the traffic forwarding strategy between different networks in the area. The covered network designates the networks belonging to this area.	
	Name	lan
	Input	Default is accept
	Output	Default is accept
	Forward	Default is accept
	IP Dynamic camouflage	The LAN port does not need to be set, and the WAN port address may change during dynamic allocation. You need to set up dynamic disguise to connect to the external network
	MSS Clamp	Automatically adjust MSS according to MTU
	Covered networks	lan
	Allow forwarding to target area	wan
	Allow forwarding from source area	unspecified
Advanced settings	The following options control the forwarding strategy between this area (lan) and other areas. The target area receives the forwarded traffic from lan. The forwarding traffic matching the source area comes from other areas whose destination is lan. The role of forwarding rules is one-way. For example, forwarding traffic from lan to wan does not mean allowing reverse forwarding of traffic from wan to lan.	
	Covered equipment	This option can classify regional traffic on original, non-UCI-hosted network devices.
	Subnets covered	This option can classify regional traffic by source or destination subnet instead of network or device.
	Restricted address	IPv4,IPv6
	To restrict the source subnet of IP dynamic masquerading	Default is empty
	Target subnets to restrict IP dynamic masquerading	Default is empty
	Enable logging in this area	Default is disable
Conntrack setting	Allow "invalid traffic"	Do not install additional rules to deny forwarded traffic with conntrack status invalid. This may be a necessary setting for complex asymmetric routing,default is disable



4G Wireless Industrial Router

Wireless Data Connectivity

	Automatic assistant assignment	Automatically assign conntrack assistant according to traffic protocol and port,default is enable.
Additional iptables parameter	By passing the iptables parameter to the source and destination traffic classification rules, you can match packets based on other conditions than the interface or subnet. Use these options with extreme caution, as invalid values may break the firewall rule set and expose all services to the outside world.	
	Additional source parameters	Additional iptables parameters are used to classify regional inflows. For example: -p tcp --sport 443 only matches inbound HTTPS traffic.
	Additional target parameters	Additional iptables parameters are used to classify regional outgoing traffic. For example: -p tcp --dport 443 only matches outbound HTTPS traffic.

5.4.8.2 Port forwards

The screenshot shows the LuCI web interface for the R40B router. The page is titled 'Firewall - Port Forwards' and includes a description: 'Port forwarding allows remote computers on the Internet to connect to a specific computer or service within the private LAN.' Below the description is a table with the following columns: Name, Match, Forward to, and Enable. The table is currently empty, with a message 'This section contains no values yet' and an 'Add' button. At the bottom of the page, there are buttons for 'Save & Apply', 'Save', and 'Reset'. The footer of the page reads 'Powered by KingPigeon Technology Co., Ltd. (v1.18) / 2020-10-16'.

Port forwarding allows remote computers on the Internet to connect to specific computers or services on the internal network.

Firewall-Port Forwarding		
Item	Description	
General Setting	Name	Forward naming
	Protocol	TCP+UDP,TCP,UDP,ICMP optional
	Source area	wan
	External port	Match inbound traffic to the specified target port or target port range on this host
	Target area	lan
	Internal IP address	Redirect matching inbound traffic to the



4G Wireless Industrial Router

Wireless Data Connectivity

Advanced settings		specified internal host
	Internal port	Redirect matching inbound traffic to the port of the internal host
	Source MAC address	Match only inbound traffic from these MACs
	Source IP address	Only match inbound traffic from this IP or IP range
	Source port	Only match inbound traffic originating from a given source port or source port range on the client host
	External IP address	Only match inbound traffic for the specified destination IP address
	Enable NAT loopback	Default is enable
Additional parameters	Extra parameters passed to iptables. use caution!	

5.4.8.3 Traffic rules

The screenshot shows the 'Firewall - Traffic Rules' page in the R40B router's web interface. The page title is 'Firewall - Traffic Rules' and it includes a brief description: 'Traffic rules define policies for packets traveling between different zones, for example to reject traffic between certain hosts or to open WAN ports on the router.' Below this, there is a table of traffic rules with columns for Name, Match, Action, and Enable. Each rule has an 'Edit' button and a 'Delete' button.

Name	Match	Action	Enable
Allow-DHCP-Renew	IPv4-UDP From any host in wan To any router IP at port 68 on this device	Accept input	<input checked="" type="checkbox"/>
Allow-Ping	IPv4-ICMP with type echo-request From any host in wan To any router IP on this device	Accept input	<input checked="" type="checkbox"/>
Allow-IGMP	IPv4-IGMP From any host in wan To any router IP on this device	Accept input	<input checked="" type="checkbox"/>
Allow-DHCPv6	IPv6-UDP From IP fe00::6 in wan To IP fe00::6 at port 546 on this device	Accept input	<input checked="" type="checkbox"/>
Allow-MLD	IPv6-ICMP with types 130/0, 131/0, 132/0, 143/0 From IP fe80::10 in wan To any router IP on this device	Accept input	<input checked="" type="checkbox"/>
Allow-ICMPv6-Input	IPv6-ICMP with types echo-request, echo-reply, destination-unreachable, packet-too-big, time-exceeded, bad-header, unknown-header-type, router-solicitation, neighbour-solicitation, router-advertisement, neighbour-advertisement From any host in wan	Accept input and limit to 1000 pkts. per second	<input checked="" type="checkbox"/>

Traffic rules define policies for packets traveling between different zones, for example to reject traffic between certain hosts or to open WAN ports on the router.

5.4.8.3 Custom rules



4G Wireless Industrial Router Wireless Data Connectivity

Firewall - Traffic Rules
Traffic rules define policies for packets traveling between different zones, for example to reject traffic between certain hosts or to open WAN ports on the router.

Traffic Rules

Name	Match	Action	Enable
Allow-DHCP-Renew	IPv4-UDP From any host in wan To any router IP at port 68 on this device	Accept input	<input checked="" type="checkbox"/>
Allow-Ping	IPv4-ICMP with type echo-request From any host in wan To any router IP on this device	Accept input	<input checked="" type="checkbox"/>
Allow-IGMP	IPv4-IGMP From any host in wan To any router IP on this device	Accept input	<input checked="" type="checkbox"/>
Allow-DHCPv6	IPv6-UDP From IP fc00::/6 in wan To IP fc00::/6 at port 346 on this device	Accept input	<input checked="" type="checkbox"/>
Allow-MLD	IPv6-ICMP with types 130/0, 131/0, 132/0, 143/0 From IP fe80::/10 in wan To any router IP on this device	Accept input	<input checked="" type="checkbox"/>
Allow-ICMPv6-Input	IPv6-ICMP with types echo-request, echo-reply, destination-unreachable, packet-too-big, time-exceeded, bad-header, unknown-header-type, router-solicitation, neighbour-solicitation, router-advertisement, neighbour-advertisement From any host in wan	Accept input and limit to 1000 pkts. per second	<input checked="" type="checkbox"/>

Custom rules allow you to execute any iptables command that is not part of the firewall framework. Each time the firewall is restarted, these commands will be executed immediately after the default rules are run.

5.5 VPN

5.5.1 IPSec

IPSec

Security Alliance

Name	Tunnel ends	State	Running time
This section contains no values yet			

Security Policy

Below is a list of configured IPSec instances and their current state

Name	Remote Gateway	Remote Subnet	Local Subnet	Enable
This section contains no values yet				

Powered by KingPigeon Technology Co., Ltd. (v1.18) / 2020-10-16

IPSec is an open network layer security framework protocol formulated by the Internet Engineering Task Force (IETF). It is not a single protocol, but a collection of protocols and services that provide security for IP networks. IPSec mainly includes security protocols AH (Authentication Header) and



4G Wireless Industrial Router

Wireless Data Connectivity

ESP (Encapsulating Security Payload), key management exchange protocol IKE (Internet Key Exchange) and some algorithms used for network authentication and encryption.

IPSec mainly provides security services for IP data packets through encryption and authentication. The security services that IPSec can provide include:

- (1) User data encryption provides data privacy through user data encryption.
- (2) Data integrity verification Through data integrity verification to ensure that data has not been tampered with on the transmission path.
- (3) Data source verification By authenticating the source of the sent data, the data is guaranteed to come from the real sender.
- (4) Prevent data replay by rejecting duplicate data packets at the receiver to prevent malicious users from attacking by repeatedly sending the captured data packets.

IPSec		
Item	Description	
IPSec Configuration	enable	Tick to enable
	Package type	Optional tunnel mode, transmission mode. Tunnel mode means host-to-host, host-to-subnet or subnet-to-subnet tunnel. The transmission mode indicates the transmission method from the host to the host.
	Peer gateway	Peer gateway which connect with IPSEC
	Local subnet IP/mask	In the tunnel mode, the tunnel from the subnet to the subnet needs to specify the local and opposite terminal network ranges
	Peer Subnet IP/Mask	In the tunnel mode, the tunnel from the subnet to the subnet needs to specify the local and opposite terminal network ranges
	Pre-shared key	Default authenticate using pre-shared key
Phase 1 settings	Phase 1 mainly negotiates encryption parameters, exchanges key information, and verifies device identity	
IKE Encryption Algorithm	Specify IKE (Internet Key Exchange) negotiation message encryption algorithm	
Authentication algorithm	Specify the digital signature authentication algorithm for encrypted messages	
DH group	Specify which key group to use for DH (DiffieHellman) key exchange	
IKE version	IKEv1 or IKEv2	
Exchange mode	Main mode or brutal mode. The main mode is more secure than the brutal mode, and the brutal mode is faster. If the responder (server) cannot know the address of the initiator (end user) in advance, or the address of the initiator is always changing, and both parties want to use the pre-shared key authentication method to create an IKE SA, Brutal mode can be used at this time	
Negotiation mode	Responder or initiator, the initiator is equivalent to the end user, and the responder is equivalent to the server	
Local ID	Can be IP address, standard domain name, email address or proper name, default is local IP	
Peer ID	Can be IP address, standard domain name, email address or	



4G Wireless Industrial Router

Wireless Data Connectivity

	proper name, default is peer IP
IKE live time	Re-negotiate the key time
Phase 2 setting	The purpose of Phase 2 is to establish an IPSec security association for data transmission
ESP Encryption Algorithm	Specify the algorithm used for data encryption
Authentication algorithm	Specify digital signature authentication algorithm for encrypted data
PFS group	PFS (Perfect Forward Secrecy), which means that a key is cracked and does not affect the security of other keys
Survive time	How long should it take from the negotiation to the connection instance
DPD detection cycle	DPD (Dead Peer Detect) ,When no traffic occurs for a period of time, the local end sends a DPD message to check the status of the peer before sending traffic

5.5.2 L2TP

L2TP (Layer 2 Tunneling Protocol, Layer 2 Tunneling Protocol) is a type of VPDN (Virtual Private Dial-up Network, Virtual Private Dial-up Network) tunneling protocol.

VPDN (Virtual Private Dial Network) refers to the use of public network (such as ISDN and PSTN) dial-up function and access network to achieve a virtual private network, providing access services for enterprises, small ISPs, and mobile office personnel.

VPDN uses a dedicated network encryption communication protocol to establish a secure virtual private network for enterprises on public networks. Enterprises abroad and business personnel can remotely connect to the corporate headquarters through a virtual encrypted tunnel through a public network, while other users on the public network cannot access resources inside the corporate network through the virtual tunnel. There are many VPDN tunneling protocols, and the most widely used is L2TP (Layer Two Tunneling Protocol).

The PPP protocol defines a encapsulation technology that can transmit multiple protocol data packets on a layer-2 point-to-point link. At this time, PPP runs between the user and the NAS (Network Access Server) network access server. The L2TP protocol provides tunnel transmission support for PPP link layer data packets, allows Layer 2 link endpoints and PPP session points to reside on different devices, and uses packet exchange technology for information exchange, thereby expanding the PPP model .

The L2TP function can be simply described as establishing a point-to-point PPP session connection on a non-point-to-point network. The L2TP protocol combines the advantages of the L2F (Layer 2 Forwarding) protocol and the PPTP (Point-to-Point Tunneling protocol) protocol, and has become the IETF industry standard for Layer 2 tunneling protocols.



4G Wireless Industrial Router Wireless Data Connectivity

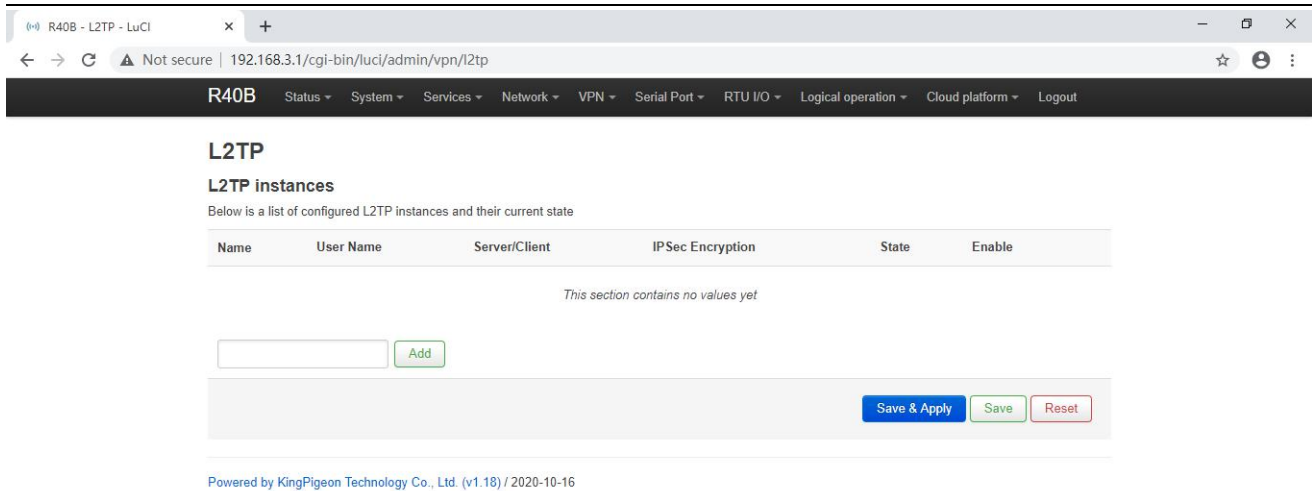

L2TP	
Item	Description
Enable	Tick to enable
Username	User name for PPP authentication
Password	Password for PPP authentication
Server/client	Server,client optional
Server address	LNS (L2TP Network Server, L2TP network server) address
IPSec encryption	You can choose whether to use IPSec encryption or not, and choose to use the default IPSec security policy during encryption. You do not need to manually configure IPSec. When you choose to use a security policy, you need to configure the IPSec policy in advance
Pre-shared key	When selecting encryption, you need to set the IPSec pre-shared key
Security strategy	Configured IPSce security policy

5.5.3 OpenVPN

OpenVPN is an application layer VPN implementation based on the OpenSSL library. It is a type of SSL VPN. It uses a virtual network card to establish a connection to transmit data, and uses SSL to encrypt and verify.

The virtual network card is a driver software implemented using the underlying network programming technology, and can be configured like other network cards. If the application accesses a remote virtual address (belongs to the address series used by the virtual network card, which is different from the real address), the operating system will send data packets (TUN mode) or data frames (TAP mode) to the virtual network card through the routing mechanism. After the service program receives the data and performs corresponding processing, it is sent from the external network through SOCKET, and the remote service program receives the data from the



4G Wireless Industrial Router

Wireless Data Connectivity

external network through SOCKET, and after corresponding processing, it is sent to the virtual network card, and the application software can receive. At this point, a one-way transmission process is completed, and vice versa. OpenVPN provides two virtual network interfaces: universal Tun/Tap driver, through which you can establish a layer 3 IP tunnel or a virtual layer 2 Ethernet. The latter can transmit any type of layer 2 Ethernet data, and the transmitted data can be passed through the LZO algorithm compression.

The SSL protocol (Secure Socket Layer) mainly uses the public key system and X.509 digital certificate technology to protect the confidentiality and integrity of information transmission. It includes: server authentication, client authentication (optional), SSL chain Data integrity on the road and data confidentiality on the SSL link. The SSL protocol is independent of the application layer protocol. High-level application layer protocols (such as HTTP, FTP, Telnet, etc.) can be transparently built on the SSL protocol. The SSL protocol has completed the encryption algorithm, communication key negotiation and server authentication before the application layer protocol communication. After that, the data transmitted by the application layer protocol will be encrypted to ensure the privacy of the communication.

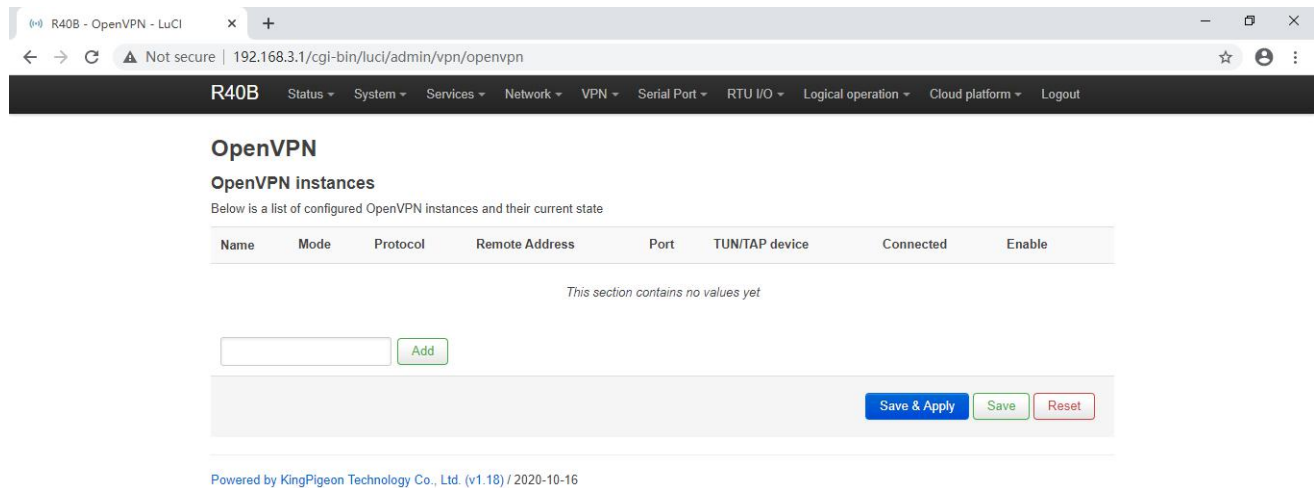

OpenVPN	
Item	Description
Enable	Tick to enable
Configure client mode	Tick to client mode
VPN Subnet IP address/mask	TAP mode, as a server, it can transmit from host to subnet
Server address	Server address which establish VPN connect with client
Port	The TCP/UDP port provided by the server for establishing a connection, default is 1194
Protocol	UDP, TCP-Server, TCP-Client, default is UDP.
TUN/TAP device	TUN mode establishes a three-layer tunnel to achieve point-to-point transmission. TAP mode establishes a Layer 2 tunnel, which can realize the transparent transmission of IP packets
Username/password	When security certificate authentication is not applicable, user



4G Wireless Industrial Router

Wireless Data Connectivity

	name/password authentication can be used
Encryption Algorithm	Choose data encryption algorithm
Authentication and authorization (root certificate)	Select file upload, root certificate provided by server
Local certificate	Select file upload, the client certificate generated by the user based on the root certificate
Local private key	Select the file upload, the key corresponding to the client certificate
DH Key exchange parameters	Used for key exchange, can be generated by openssl dhparam -out dh2048.pem 2048
Compression algorithm	LZO,LZ4
Keepalive interval (seconds)	The interval at which the server sends a probe message to the client
Keepalive timeout (seconds)	If the server does not receive a response to the probe message at this time, it restarts the connection

Note: When uploading the certificate file, you need to find the directory where the file is saved after you click to select the file, and then select the file after the upload is complete.

5.6 Serial Port

5.6.1 Serial Port settings

Serial Port Settings		
Item	Description	
Modbus Device ID	Range 1~247,default is 1	
RS485	Baud rate	1200,2400,4800,9600,14400,19200,38400,57600,115200,230400 optional
	Data bit	5,6,7,8
	Parity	None, Even and Odd optional
	Stop Bit	1,2 optional
RS232	Baud rate	1200,2400,4800,9600,14400,19200,38400,57600,115200 optional
	Data bit	5,6,7,8 optional
	Parity	None, Even and Odd optional
	Stop Bit	1,2 optional

5.6.2 Serial Port Application



4G Wireless Industrial Router

Wireless Data Connectivity

R40B - Serial Port Application

192.168.3.1/cgi-bin/luci/admin/serial/ser2net

R40B Status System Services Network VPN Serial Port RTU I/O Logical operation Cloud platform Logout

Serial Port

Serial State

Index	Serial Name	Serial Type	Received Bytes	Transmitted Bytes	Clear Statistics
This section contains no values yet					

Parameter Setting

Device	Baudrate	Usage Mode	Net Protocol type	Host IP or Domain	Port	
						<input type="button" value="Edit"/> <input type="button" value="Delete"/>
						<input type="button" value="Edit"/> <input type="button" value="Delete"/>

Powered by KingPigeon Technology Co., Ltd. (v1.18) / 2020-10-16

Serial Port Application	
Item	Description
Enable	Tick to enable
Device	RS485 or RS232
Mode	transparent transmission,Modbus RTU to TCP、 Modbus slave
Modbus Device ID	Set when mode is modbus slave,default is 1,please modify in the serial port settings
Network Protocol	TCP server,TCP client,UDP server,UDP client
Host IP or domain name	Select the client to be visible, set the connection server address here
Port	Set the connection server port when the client is selected, and set the local listening port when the server is selected
Login Message	Server register handshake protocol package
Heartbeat Message	Heartbeat content to avoid network offline
Heartbeat ACK Message	The server responds to the heartbeat packet
Heartbeat Interval(s)	Network keep online heartbeat interval time,default is 60s
Retransmission Times(s)	if server no response, the times which server will send data

5.6.3 Modbus Master



4G Wireless Industrial Router

Wireless Data Connectivity

R40B - Modbus Master - LuCI

192.168.3.1/cgi-bin/luci/admin/serial/modbus

R40B Status System Services Network VPN Serial Port RTU I/O Logical operation Cloud platform Logout

Modbus Master

Modbus Setting

Name	Alias	Slave Address	Register Type	Function Code	Register Start Address	Data Number	Mapping Address	Enable	Query	Detail Settings	
This section contains no values yet											
		<input type="text"/>	<input type="button" value="Add"/>								
								<input type="button" value="Save & Apply"/>	<input type="button" value="Save"/>	<input type="button" value="Reset"/>	

Powered by KingPigeon Technology Co., Ltd. (v1.18) / 2020-10-16

R40B - LuCI

192.168.3.1/cgi-bin/luci/admin/serial/modbus/detail/test

R40B Status System Services Network VPN Serial Port RTU I/O Logical operation Cloud platform Logout

Config Detail

Config Detail

Mapping Address	Alias	Data Type	Input Type	Confirm time(s)	Enable alarm	Action	Hold time(s)	Publish
64	<input type="text"/>	Bool	Open	<input type="text"/>	<input type="checkbox"/>	None	<input type="text"/>	<input checked="" type="checkbox"/>
65	<input type="text"/>	Bool	Open	<input type="text"/>	<input type="checkbox"/>	None	<input type="text"/>	<input checked="" type="checkbox"/>
66	<input type="text"/>	Bool	Open	<input type="text"/>	<input type="checkbox"/>	None	<input type="text"/>	<input checked="" type="checkbox"/>
67	<input type="text"/>	Bool	Open	<input type="text"/>	<input type="checkbox"/>	None	<input type="text"/>	<input checked="" type="checkbox"/>
68	<input type="text"/>	Bool	Open	<input type="text"/>	<input type="checkbox"/>	None	<input type="text"/>	<input checked="" type="checkbox"/>
69	<input type="text"/>	Bool	Open	<input type="text"/>	<input type="checkbox"/>	None	<input type="text"/>	<input checked="" type="checkbox"/>
70	<input type="text"/>	Bool	Open	<input type="text"/>	<input type="checkbox"/>	None	<input type="text"/>	<input checked="" type="checkbox"/>
71	<input type="text"/>	Bool	Open	<input type="text"/>	<input type="checkbox"/>	None	<input type="text"/>	<input checked="" type="checkbox"/>
72	<input type="text"/>	Bool	Open	<input type="text"/>	<input type="checkbox"/>	None	<input type="text"/>	<input checked="" type="checkbox"/>
73	<input type="text"/>	Bool	Open	<input type="text"/>	<input type="checkbox"/>	None	<input type="text"/>	<input checked="" type="checkbox"/>

Note: Modbus master settings need to be selected device model to support this function will be displayed.

Modbus Master	
Item	Description
Enable	Tick to enable
Slave address	Slave Modbus device ID,If the cloud connection setting selects Modbus protocol, please set an address different from the local Modbus device ID
Register type	Boolean,16-bit, 32-bit, 64-bit
Function code	01,02,03,04; 01/02 Function codes apply to Boolean data types, 03/04



4G Wireless Industrial Router

Wireless Data Connectivity

	Function codes apply to 16/32/64 bit data type; 01 function code supports 05/15 function code at the same time, 03 function code supports 06/16 function code at the same time.	
Register start address	Set according to slave register address	
Data number	Set according to the number of slave registers	
Mapping address assignment	Automatic / manual	
Mapping start address	Select Manual Assignment Visible; Boolean type mapping register address 64~256, 16 bit type mapping register address 20000~20127, 32 bit type mapping register address 20128~20254, 64 bit type mapping register address 20256~20508	
Timed reading cycle (seconds)	Data collection cycle	
Slave interface	RS485,RS232,Ethernet If RS485 or RS232 is already connected as a serial device, this is not visible here	
Slave IP address	Visible when selecting Ethernet	
Port	Visible when selecting Ethernet	
Serial setting	Can be set when slave interface select RS485 or RS232	
	Device	RS485 or RS232
	Baud rate	1200, 2400, 4800, 9600, 14400, 19200, 38400, 57600, 115200, 230400, 460800
	Data bits	5,6,7,8
	Parity Bit	None, Even and Odd optional
	Stop Bit	1,2
Detailed configuration	Mapping address	Slave register address
	Data type	Slave register data type
	Input type	Boolean data type is visible
	Coefficient	16/32/64 bit data type is visible,ratio coefficient between register value and real value
	Confirm time (s)	16/32/64 bit data type is visible, Over-threshold confirmation trigger time
	High threshold	16/32/64 bit data type is visible
	Low threshold	16/32/64 bit data type is visible
	Action	Linkage local DO close or open
	Hold time	Do action time
	Publish	Tick to publish data via MQTT



5.7 RTU IO

5.7.1 E-mail & SMS

The screenshot shows the 'Email & SMS Setting' page in a browser. The page title is 'R40B - Email&SMS Setting - L'. The browser address bar shows '192.168.3.1/cgi-bin/luci/admin/io/email'. The navigation menu includes: R40B, Status, System, Services, Network, VPN, Serial Port, RTU I/O, Logical operation, Cloud platform, and Logout. The 'Email' section has a sub-section 'Email Setting' with the following fields: 'Enable send email' (checkbox), 'Email Server' (text box with 'smtp.xxx.com'), 'Port' (text box with '25'), 'Recipient name' (text box with 'recipient@xxx.com'), 'Sender name' (text box with 'sender@xxx.com'), 'User Name' (text box with 'user name'), and 'Password' (password field). The 'SMS Setting' section is currently empty with the message 'This section contains no values yet'. At the bottom right of the form are buttons for 'Save & Apply', 'Save', and 'Reset'. A footer note reads 'Powered by KingPigeon Technology Co., Ltd. (v1.18) / 2020-10-16'.

E-mail setting	
Item	Description
Enable send mail	Tick to allow send e-mail
Mail Server	Enter the SMTP mail server address
Port	Enter the SMTP mail server port number
Recipient name	Enter mail receiving address, you can add multiple, enter an address and click the "+" on the right to save, at the same time the second input box will appear below, you can continue to add or leave blank to no longer add
Sender name	Enter the email sending account address
User name	Enter the email sending account username
Password	Enter the email sending account address password

Note: The mail server needs to be enabled with the SMTP service. If the mail is not sent successfully, please make sure that the SMTP service is enabled in the mailbox settings and the account password is entered correctly.

5.7.2 Digital input/output

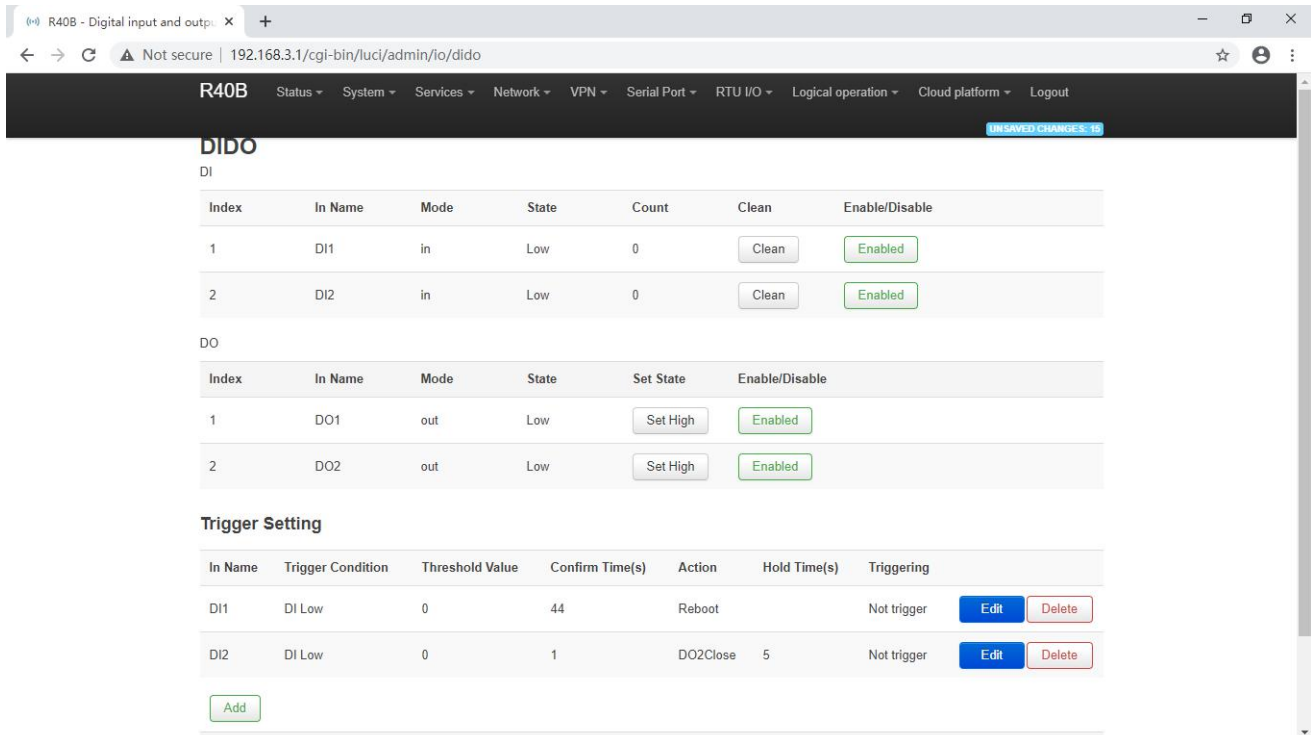

DIDO

DI

Index	In Name	Mode	State	Count	Clean	Enable/Disable
1	DI1	in	Low	0	<input type="button" value="Clean"/>	<input type="button" value="Enabled"/>
2	DI2	in	Low	0	<input type="button" value="Clean"/>	<input type="button" value="Enabled"/>

DO

Index	In Name	Mode	State	Set State	Enable/Disable
1	DO1	out	Low	<input type="button" value="Set High"/>	<input type="button" value="Enabled"/>
2	DO2	out	Low	<input type="button" value="Set High"/>	<input type="button" value="Enabled"/>

Trigger Setting

In Name	Trigger Condition	Threshold Value	Confirm Time(s)	Action	Hold Time(s)	Triggering
DI1	DI Low	0	44	Reboot		Not trigger <input type="button" value="Edit"/> <input type="button" value="Delete"/>
DI2	DI Low	0	1	DO2Close	5	Not trigger <input type="button" value="Edit"/> <input type="button" value="Delete"/>

You can view the current status of DI and DO, the DI count value, set the type of DO normally open and normally closed, enable and disable the operation of DI and DO, and trigger settings can add DI trigger conditions.

Trigger Setting	
Item	Description
Input	DI1,DI2
Trigger conditions	NO,NC,Counting over threshold, Recovery
Threshold value	The threshold value should be entered when the condition selection count exceeds the threshold
Confirmation time (seconds)	The condition will reach the set time will confirm the trigger
Action	Linkage action: No,DO1,DO2,all DO, Reboot
DO status	Open,close,When the action selects DO, the execution state should be selected
Hold time (seconds)	DO action time
Trriggering	Tick to enable alarm

Digital output Instructions

Wiring

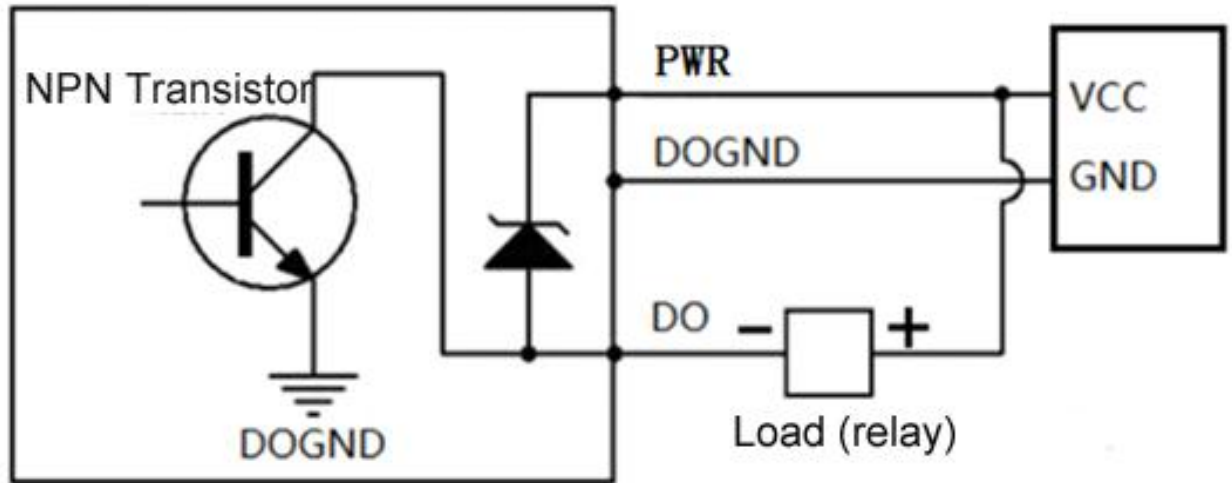

instruction:

Digital output	qty	2
	type	SINK output
	Load voltage	Max 50VDC
	Load current	500mA (single) ,625mW
	protection	EFT: 40A (5/50ns)

5.7.3 Analog input

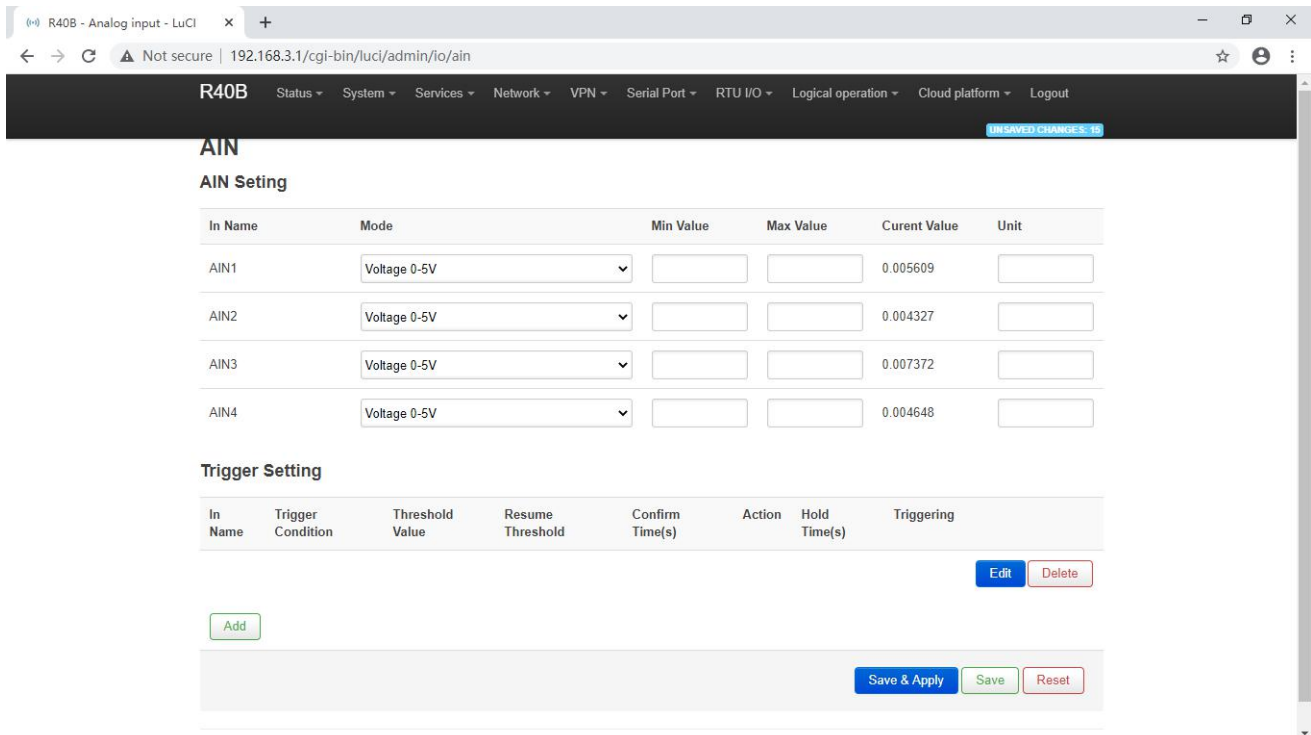

AIN Setting

In Name	Mode	Min Value	Max Value	Current Value	Unit
AIN1	Voltage 0-5V			0.005609	
AIN2	Voltage 0-5V			0.004327	
AIN3	Voltage 0-5V			0.007372	
AIN4	Voltage 0-5V			0.004648	

Trigger Setting

In Name	Trigger Condition	Threshold Value	Resume Threshold	Confirm Time(s)	Action	Hold Time(s)	Triggering
Add Edit Delete							
Save & Apply Save Reset							

You can view the current AI value and set the mode: voltage 0~5V, current 4~20mA. Current 0~20mA, set the minimum value and unit of the range, trigger setting can add AI trigger condition.

Trigger



4G Wireless Industrial Router

Wireless Data Connectivity

Item	Description
Input	AIN1,AIN2,AIN3,AIN4
Trigger condition	Analog input is greater than the threshold, analog input is less than the threshold
Threshold value	The condition will be triggered when the set value is reached
Resume threshold	When the set value is reached, it will be regarded as recovery
Confirm time (seconds)	Confirm the trigger when condition reach the set time
Action	Linkage action: No,DO1,DO2,all DO, Reboot
DO status	Open,close,When the action selects DO, the execution state should be selected
Hold time (seconds)	DO action time
Trriggering	Tick to enable alarm

5.7.4 Device Monitor

The screenshot shows the 'Device Monitor' configuration page in a web browser. The browser address bar shows '192.168.3.1/cgi-bin/luci/admin/fo/monitor'. The page has a dark navigation bar with 'R40B' and various menu items. Below the navigation bar, the title 'Device Monitor' is displayed. A table with 8 columns is shown, but it is empty. A green 'Add' button is located below the table. At the bottom right, there are three buttons: 'Save & Apply' (blue), 'Save' (green), and 'Reset' (red). A footer at the bottom of the page reads 'Powered by KingPigeon Technology Co., Ltd. (v1.18) / 2020-10-16'.

Device Monitor	
Item	Description
Register address	Range 2~63
In name	DI3~DI64 , Automatically generated according to the register address, MQTT report data identifier
Device IP address	Detect IP
PING times	According to the set value PING how many times, if there is no PING, then the detection equipment is disconnected from the network



4G Wireless Industrial Router Wireless Data Connectivity

Action	Linkage DO close or open
Hold time (seconds)	DO action time
Trriggering	Tick to enable alarm

5.7.5 Event and Alarm

Event And Alarm

Index	Alarm Name	Alarm Description	Alarm Time
This section contains no values yet			

Add Alarm

Alarm Name	Send SMS	Short Message Content	Send Email	Email Content	
DI1 open	<input checked="" type="checkbox"/>	<input type="text"/>	<input checked="" type="checkbox"/>	<input type="text"/>	Delete
DI1 open	<input checked="" type="checkbox"/>	<input type="text"/>	<input checked="" type="checkbox"/>	<input type="text"/>	Delete
DI1 open	<input checked="" type="checkbox"/>	<input type="text"/>	<input checked="" type="checkbox"/>	<input type="text"/>	Delete

Add

Save & Apply Save Reset

Powered by KingPigeon Technology Co., Ltd. (v1.18) / 2020-10-16

When the trigger conditions are set in the Modbus master , digital input and output, analog input, network disconnection detection and alarm related settings and the alarm is enabled, the related alarm events can be seen here. You can set related alarm messages and content of email.

5.7.6 Timer

Timer

Please make sure that the time set is consistent with your time zone

Cycle Timer

Week day	Hour	Minute	Action	Enable
This section contains no values yet				

Add

Once Timer

Month	Day	Hour	Minute	Action	Enable
This section contains no values yet					

Add

Save & Apply Save Reset

Powered by KingPigeon Technology Co., Ltd. (v1.18) / 2020-10-16



4G Wireless Industrial Router

Wireless Data Connectivity

R40B state system service The internet VPN application RTU I/O logic operation cloud platform quit

UNSAVED CONFIGURATION : 2

Timer

Timer setting

Alias:

Time interval:

time unit:

action:

DO status:

Hold time (seconds):

Start/stop time:

Start time (hours):

Start time (minutes):

Stop condition:

Cycles:

Timed task: can choose to close or open DO, send mail, and restart.

Cycle timer: can be executed daily or weekly.

Once timer: can be executed regularly according to the specified date

Timer Setting: Set cycles or duration for certain actions

5.8 Logical Operation

R40B - Logical operation - LuCI

Not secure | 192.168.3.1/cgi-bin/luci/admin/logic/logic

R40B Status System Services Network VPN Serial Port RTU I/O Logical operation Cloud platform Logout

UNSAVED CHANGE : 16

Logical operation

Bool input

Name	Input1	Condition	Relationship	Input2	Condition	Output Address	Output Value	Logic Value	
1	REG64	Open	Logic And	DI1	Open	REG64	Open	1	<input type="button" value="Edit"/> <input type="button" value="Delete"/>

Numerical input

Name	Input1	Condition	Threshold	Relationship	Input2	Condition	Threshold	Output Address	Output Value	Logic Value
------	--------	-----------	-----------	--------------	--------	-----------	-----------	----------------	--------------	-------------

This section contains no values yet

Combined input

Name	Input1	Condition	Relationship	Input2	Condition	Output Address	Output Value	Logic Value
------	--------	-----------	--------------	--------	-----------	----------------	--------------	-------------

This section contains no values yet

Provides powerful local logic operation function, and can freely set various combinations between local I/O (digital input and output, analog input) and slave I/O (slave register set by Modbus master) Linkage.



4G Wireless Industrial Router Wireless Data Connectivity

5.9 Cloud Platform

5.9.1 Private Cloud

R40B Status System Services Network VPN Serial Port RTU I/O Logical operation Cloud platform Logout

Cloud connection settings

Cloud connection settings

Enable setting

Cloud platform King Pigeon IIoT V2

Link Protocol MODBUS RTU

Modbus Device ID 1
Modbus device ID is set in Serial Port Settings

Register Packet

Heartbeat Packet

Heartbeat Response Packet

Heartbeat Period(s) 60

Host Silence Time(s) 600

Save & Apply Save Reset

Powered by KingPigeon Technology Co., Ltd. (v1.18) / 2020-10-16

Cloud Platform

Customized Cloud (MQTT protocol supports customized data format)

R40B state system service The internet VPN application RTU I/O logic operation cloud platform quit

Cloud connection settings

Cloud connection settings

cloud platform Other cloud platforms

Cloud platform name

Host IP or domain name modbus.dtuip.com

port 6651

Link Agreement MQTT

MQTT client ID

username MQTT

password

encryption Not encrypted

Release data format Custom data format

Subscribe to topics Custom data format

Release period (seconds)

Posted by QOS 0-at most once

Custom data format



4G Wireless Industrial Router

Wireless Data Connectivity

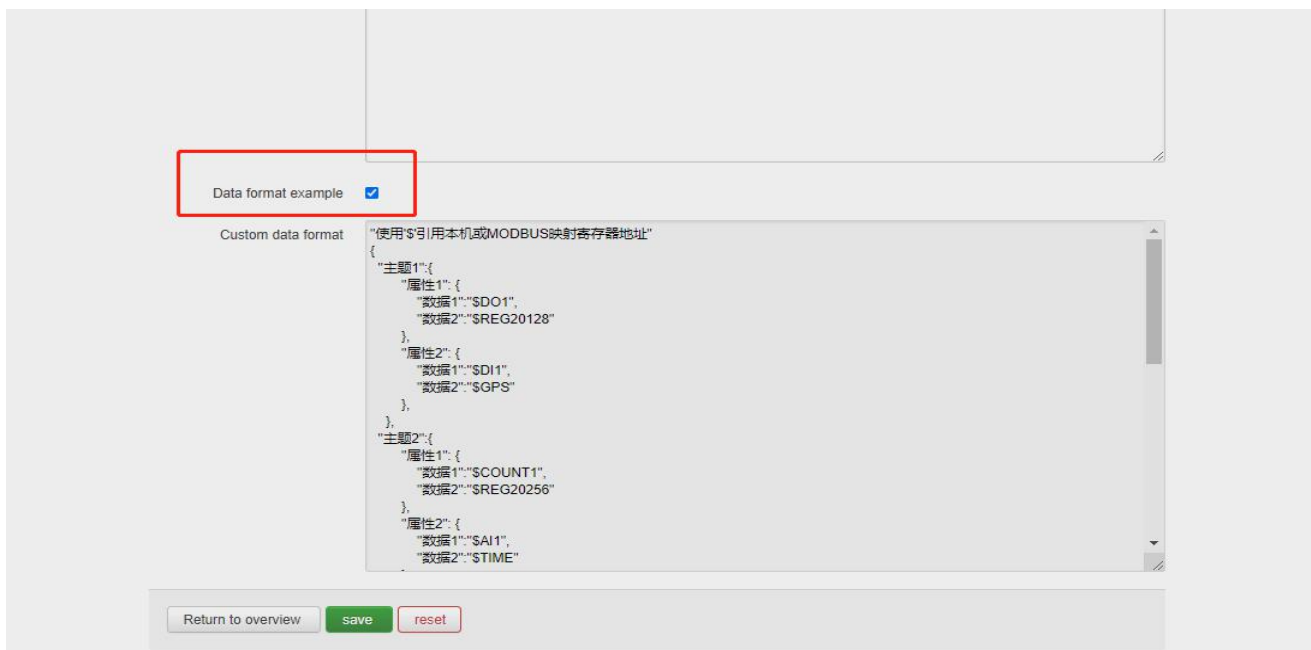

Cloud Connection Settings		
Item	Description	
Enable setting	Tick to enable	
Cloud Platform	King Pigeon IIOT V2,IIOT V3,others	
Host IP or domain name	Connect Server Port	
Port	Connect to other cloud platform server ports	
Link Protocol	Modbus RTU,Modbus TCP ,MQTT	
Modbu Protocol Parameters	Modbus Device ID	Default is 1
	Register packet	Server register handshake protocol package,if need contact salesman
	Heartbeat packet	Heartbeat content to avoid network offline
	Heartbeat response packet	The server responds to the heartbeat packet
	Heartbeat period (s)	Network keep online heartbeat interval time
	Host Silence time (s)	The server sends silent time without data, and will reconnect if it times out
MQTT Protocol Parameters	MQTT Client ID	The client identifier used in the MQTT connection message, the server uses the client identifier to identify the client, and each client connected to the server has a unique client identifier.
	Username	The user name used in the MQTT connection message, which can be used by the server for authentication and authorization.
	Password	The password used in the MQTT connection message, which can be used by the server for authentication and authorization.
	Publish topic	The subject name used in the MQTT publish message. The subject name is used to identify the information channel to which the payload data should be published. The subject name in the publish message cannot contain wildcards.



4G Wireless Industrial Router

Wireless Data Connectivity

Subscribe topic	The topic name used in MQTT subscription messages. After the subscription, the server can send publish messages to the client to achieve control.
Publish Period (seconds)	MQTT data timing publish interval
Publisher QOS	Service quality level guarantee for application message distribution: 0-at most once, 1-at least once, 2-only once
Encryption	Optional unencrypted, encrypted (root certificate), encrypted (self-signed)
Authentication and authorization (root certificate)	Choose file upload
Local certificate	Choose file upload
Local private key	Choose file upload
Enable data transfer	Enable to work
Data packing	Send multiple data in one message
Customize the MQTT protocol	Custom MQTT protocol supports user-defined data formats,

5.9.2 Ali Cloud

The screenshot shows the 'Cloud connection settings' page in the R40B router's web interface. The page includes a navigation menu at the top with options like Status, System, Services, Network, VPN, Serial Port, RTU I/O, Logical operation, Cloud platform, and Logout. The main content area is titled 'Cloud connection settings' and contains the following fields:

- Enable setting:
- Authentication method: Device Serect (dropdown)
- Product Key(ProductKey):
- Device Name(DeviceName):
- Device Serect(DeviceSerect):
- Region ID: -- Please choose -- (dropdown)
- Publish Period(s): > 60 (text input)

At the bottom right of the settings area, there are three buttons: 'Save & Apply' (blue), 'Save' (green), and 'Reset' (red). The footer of the page reads 'Powered by KingPigeon Technology Co., Ltd. (v1.18) / 2020-10-16'.

Ali Cloud Connection Settings	
Item	Description
Enable setting	Tick to enable
Authenticatioin method	Device secret key, X509 certificate
Product Key	Set the product key on Alibaba Cloud
Device Name	Set the device name on Alibaba Cloud
Device Serect	Set the device key on Alibaba Cloud
Region ID	Ali cloud region



4G Wireless Industrial Router

Wireless Data Connectivity

Publish period (seconds)	>60
Certification authority (root certificate)	Choose file upload
Local certificate	Choose file upload
Local key	Choose file upload

5.9.3 AWS Cloud

The screenshot shows the 'Cloud connection settings' page for the R40B router. The page includes a navigation menu at the top with options like Status, System, Services, Network, VPN, Serial Port, RTU I/O, Logical operation, Cloud platform, and Logout. The main content area is titled 'Cloud connection settings' and contains the following fields:

- Enable setting:
- Host(EndPoint):
- Client ID:
- Thing Name:
- Publish Topic:
- Publish Period(s):
- Certificate authority: (Selected: /etc/mqtt/root.crt)
- Local certificate: (Selected: /etc/mqtt/local.crt)
- Local private key: (Selected: /etc/mqtt/private.key)

AWS Cloud Connection Settings	
Item	Description
Enable setting	Tick to enable
Host (Endpoint)	Set End point
Clint ID	The client identifier used in the MQTT connection message, the server uses the client identifier to identify the client, and each client connected to the server has a unique client identifier.
Thing name	Set thing name
Publish topic	The subject name used by MQTT to publish messages. The subject name is used to identify which information channel the payload data should be published to. The subject name in the published message cannot contain wildcards.
Publish period (seconds)	>60
Certification authority (root certificate)	Choose file upload
Local certificate	Choose file upload
Local key	Choose file upload



4G Wireless Industrial Router Wireless Data Connectivity

5.9.4 HuaweiCloud

HUAWEI CLOUD supports access to the cloud platform in two ways: device secret key and authentication certificate:

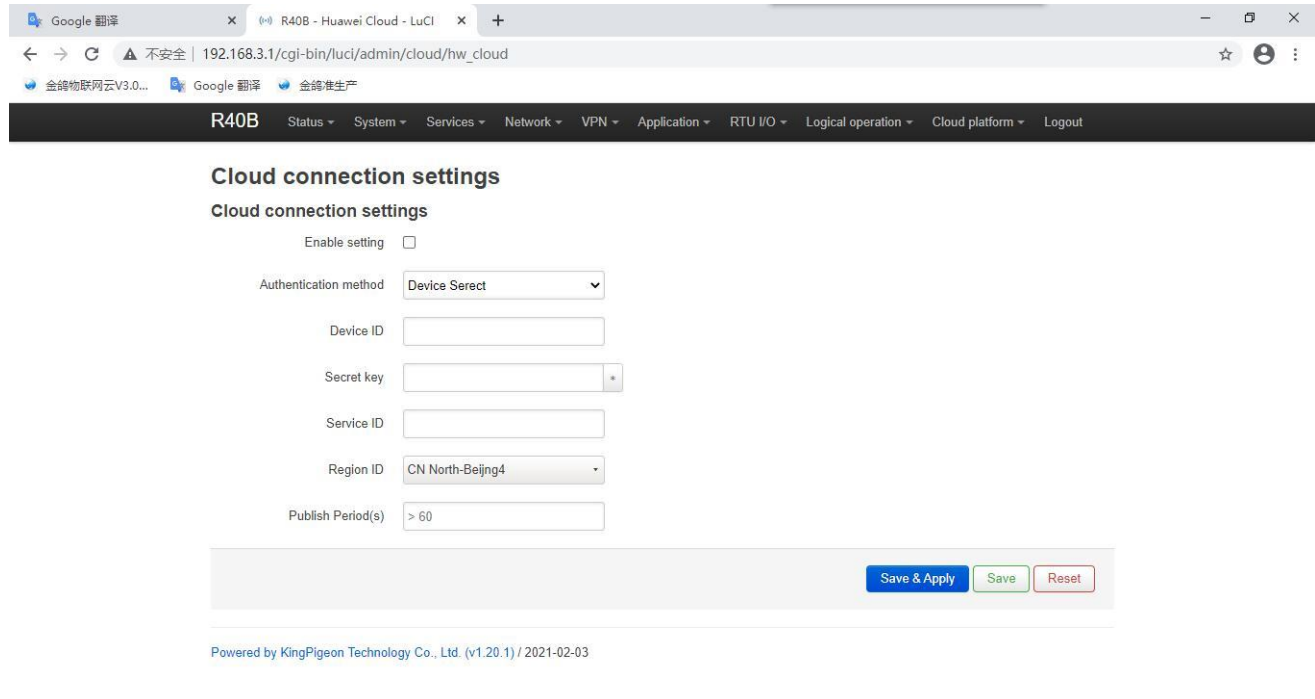

Huaweicloud connection settings	
Item	Description
Enable setting	Tick to enable
Authentication method	The device secret key method and the authentication certificate method can be selected, and the authentication certificate method needs to upload the certificate
Devicde ID	<p>The ID of the device when HUAWEI CLOUD creates the device, eg,</p> <p>R40A ● Offline</p> <hr/> <p>Node ID R40A </p> <p>Device ID 5ee965a0496bac073bb6120d_R40A </p> <p>Registered Jun 17, 2020 08:37:57 GMT+08:00</p> <p>Node Type Directly connected</p> <p>Software Version v1.0</p>
Service ID	The product needs to create a service to report data, eg.



4G Wireless Industrial Router

Wireless Data Connectivity

	<p>Model Definition Online Debugging Topic Management</p> <p>Add Service Import Library Model Import Local Profile Import from Excel</p> <p>Service ID: R40</p>
Region ID	The location of the device can be queried on the HUAWEI CLOUD platform
Publish Period (s)	Above 60s
Secret key	For the password entered when creating the device certificate, you can refer to the HUAWEI CLOUD help document to create a test certificate
Certification authority (root certificate)	Root certificate provided by Huawei:rootcert.pem, It's included in the release version, generally don't need to upload
Device certificate	Device certificate deviceCert.pem,Upload to the /etc/conf directory and select the file, you can refer to the HUAWEI CLOUD help document to create a test certificate
Device key	Device key/deviceCert.key,Upload to the /etc/conf directory and select the file, you can refer to the HUAWEI CLOUD help document to create a test certificate

For the steps of creating and registering devices on the platform, please refer to the help documents of Huawei Cloud.

5.9.5 ThingsBoard Cloud

The screenshot shows the 'Thingsboard cloud settings' page. At the top, there is a navigation bar with 'R40B' and various menu items like 'state', 'system', 'service', etc. The main content area is titled 'Thingsboard cloud settings' and contains a section for 'Cloud connection settings'. This section includes several form fields: 'Enable settings' (checkbox), 'MQTT client ID', 'username', 'password' (with a visibility toggle), and 'Release period (seconds)'. Below these are two more checkboxes: 'Enable data transfer' and 'Only release changed data'. At the bottom of the settings area are three buttons: 'Save and apply', 'save', and 'reset'. A footer note at the bottom of the page reads 'Powered by KingPigeon Technology Co., Ltd. (v1.20.10) / 2021-09-09'.

ThingsBoard Cloud Connection Setting	
Item	Description
Enable Setting	Tick it to enable ThingsBoard Cloud



4G Wireless Industrial Router

Wireless Data Connectivity

Console (terminal point)	Set terminal point
Client ID	Client identification mark of MQTT connecting message. Server uses it to identify client. Each client connected to server has its own unique client identification mark
Item Name	Set item name
Publish Topic	Topic of MQTT publishing messages. It's used for identifying the information channel to send valid payload data. The topic can't include wildcard character
Publishing Cycle (second)	Must be ≥ 60 s
Authorization Certificate(Root Certificate)	Select file to upload it
Local Certificate	Select file to upload it
Local Secret Key	Select file to upload it
Enable Data Re-transmission	Tick it to enable data re-transmission once network recovers
Only release changed data	Tick it to upload changed data only

5.10 Logout

After the router parameter configuration is complete, click "Logout", the device will log out and return to the login web configuration page.

6. Communication Protocol

The device supports Modbus RTU protocol, Modbus TCP protocol and MQTT protocol. For specific communication protocol, please refer to relevant materials. The following introduces the application of Modbus RTU and MQTT protocol on the device.

Modbus TCP and RTU protocol are very similar, as long as an MBAP header is added to the RTU protocol, and the two byte CRC check code of the RTU protocol can be removed.

6.1 Modbus RTU Protocol

6.1.1 Platform connection setting



4G Wireless Industrial Router

Wireless Data Connectivity

R40B - Custom Cloud - LuCI x +

Not secure | 192.168.3.1/cgi-bin/luci/admin/cloud/host_set

R40B Status System Services Network VPN Serial Port RTU I/O Logical operation Cloud platform Logout

Cloud connection settings

Cloud connection settings

Enable setting

Cloud platform King Pigeon IIoT V2

Link Protocol MODBUS RTU

Modbus Device ID 1
 Modbus device ID is set in Serial Port Settings

Register Packet

Heartbeat Packet

Heartbeat Response Packet

Heartbeat Period(s) 60

Host Silence Time(s) 600

Save & Apply Save Reset

Powered by KingPigeon Technology Co., Ltd. (v1.18) / 2020-10-16

1. Set the platform server IP and port, select Modbus RTU protocol and set the local Modbus device ID (the effective range of Modbus device ID is 1~247)
2. Set relevant message information according to the platform to be connected (if not, you can not set it)
 [Registrar Package]: The registration package sent by the device to the server when connected to the server.
 [Heartbeat Packet]: A heartbeat packet sent by the device to the server to maintain the connection.
 [Heartbeat period]: The heartbeat packet sending period.
 [Host Silent Time]: Silent time when no data is sent from server, timeout will reconnect.

6.1.2 Read Device Register Address

6.1.2.1 DI / DO / AI DI pulse counter Register Address

1) Read input Coil(Function Code 02:Read coil)

Modbus Register Address(Decimal)	PLC or configuration address (Decimal)	Data Name	Data Type	Description
0	10001	DI1	Bool	Dry contact: 0: Open 1: Close
1	10002	DI2		Wet contact: 0: Low level (0~1VDC) 1: High level (5~30VDC)
2~21	10003~10022	Network disconnection detection device IP (max 20 IPs can be set)		0:offline 1:online



4G Wireless Industrial Router

Wireless Data Connectivity

2) Read & Write Holding Coil (Function Code 01, Function Code 05, Function Code 15)

Modbus Register Address(Decimal)	PLC or configuration address (Decimal)	Data Name	Data Type	Description
0	00001	DO1	Bool	0: Open 1: Close
1	00002	DO2		

3) Read input Register (Function Code 04:Read input register.)

Modbus Register Address(Decimal)	PLC or configuration address (Decimal)	Data Name	Data Type	Description
0~1	30001~30002	AI1	(32 Bit Float) ABCD	Real value = register value
2~3	30003~30004	AI2		
4~5	30005~30006	AI3		
6~7	30007~30008	AI4		
8~9	30009~30010	DI1 pulse counter	32-bit unsigned integer ABCD	
10~11	30011~30012	DI2 pulse counter		

6.1.2.2 Read Device Digital input Status

Master Send Data Format

Content	Byte	Data	Description
Device address	1	01H	01H Device, Range: 1-247, according to setting address
Function code	1	02H	02 read input coil DIN status
DIN Register address	2	00 00H	Range:0000H-0001H,stands for DI1-DI2
Read DIN register Qty	2	00 02H	Range:0001H-0002H, read qty of DIN status
16CRC verify	2	F9 CBH	CRC0 CRC1 low byte in front, high byte behind

Receiver Return Data Format

Content	Byte	Data	Description
Device address	1	01H	01H Device, according to setting address
Function code	1	02H	Read input holding coil
Return bytes Qty	1	01H	Return data length
Returning data	1	01H	Return DI data
16CRC Verify	2	6048H	CRC0 CRC1 low byte in front, high byte behind

Example: Inquiry device 2 DIN data at same time, then:

Server send: 01 02 00 00 00 02 F9 CB

01= Device address; 02= Inquiry DIN status; 00 00= DIN Starting address; 00 08= Serial reading 2 DIN status; F9 CB = CRC verify.

Device return: 01 02 01 01 60 48

01= Device address; 02= Inquiry DIN status; 01= Returning data bytes qty; 01= DIN status, each byte stands for one DIN status, 01H converter to binary 0000 0001 from low to high byte, stands for DIN1-DIN2 status,



4G Wireless Industrial Router

Wireless Data Connectivity

0= Open, 1= Close.

DI2	DI1
0	1
Open	Close

60 48: 16 byte CRC verify.

If need to inquiry multi DIN status, only need to change "DIN Starting Address", "Reading DIN Register Qty", calculate CRC verify again.

6.1.2.3 Read Device Digital Output DO Status

Master Send Data Format:

Content	Bytes	Data (H: HEX)	Description
Device Address	1	01H	01H Device, Range: 1-247, according to setting address
Function Code	1	01H	Read the hold coil, function code 01
Register Starting Address	2	00 00H	Range: 0000H-0001H, stands for DO1-DO2
Read Register Qty	2	00 02H	Range: 0000H-0001H
16 CRC Verify	2	BD CBH	CRC0 CRC1 low byte in front, high behind

Receiver Return Data Format:

Content	Bytes	Data (H: HEX)	Description
Device Address	1	01H	01H device, consistent with download data
Function Code	1	01H	Read the hold coil
Return Bytes Qty	1	01H	Return data length
Returning Data	1	02H	Data returned
16 CRC Verify	2	D0 49H	CRC0 CRC1 low byte in front, high behind

Example: Read 2 DO states, device address 1, then,

Server Send: 01 01 00 00 00 02 BD CB

01= Device address; 01= Read Relay DO function code; 00 00= Register starting address; 00 02= Continuous reading of 2 DO data; BD CB= CRC verify.

Device Answer: 01 01 01 02 D0 49

01= Device address; 01= Read relay function code; 01=Return data bytes Qty; 02=The returned data is converted into binary: 0000 0010 from low to high byte, status value:

DO2	DO1
1	0
Close	Open

D0049: 16 byte CRC verify

If you want to read the state of a DO or several DO states, you only need to modify the "DO register start address" and "the number of read registers", then recalculate the CRC, and the returned data is parsed according to the above description.



6.1.2.4 Control Device Digital Output Status

1) Control 1 channel device DO output

Master Send Data Format:

Content	Bytes	Data (H: HEX)	Description
Device Address	1	01H	01H Device, Range: 1-247, according to setting address
Function Code	1	05H	Write single holding coil type, function code 05
DO Register Address	2	00 00H	Range: 0000H-0003H
Active	2	FF 00H	This value: FF 00H or 00 00H, FF 00H= Close relay, 00 00H= Open relay
16CRC Verify	2	8C 3AH	CRC0 CRC1 low byte in front, high behind

Receiver Return Data Format:

Content	Bytes	Data (H: HEX)	Description
Device Address	1	01H	01H Device, according to the data Master send
Function Code	1	05H	Write single holding coil type
DO Register Address	2	00 00H	Range: 0000H-0003H
Active	2	FF 00H	This value: FF 00H or 00 00H, FF 00H= Already activated close relay, 00 00H= Already activated open relay
16CRC Verify	2	8C 3AH	CRC0 CRC1 low byte in front, high behind

Example: Control relay DO1 close, then:

Server send: 01 05 00 00 FF 00 8C 3A

01=Device address;05= Control single relay command;00 00=Relay DO0 address;FF 00=DO0 close;8C 3A=CRC verify.

Device answer: 01 05 00 00 FF 00 8C 3A

01=Device address;05=Control single relay command;00 00=Relay DO0 address;FF 00= Active DO0 close; 8C 3A=CRC verify.

If single control other relay outputs, only need to change "DO Register Address" and "Active", calculate CRC verify again.

2) Multiple Control DO outputs

Master Send Data Format:

Content	Bytes	Data (H: HEX)	Description
Device Address	1	01H	01H Device, Range: 1-247,according to setting address
Function Code	1	0FH	Write multi holding coil,function code 15
DO Starting Register Address	2	00 00H	Range: 0000H-0001H, stands for DO0-DO1



4G Wireless Industrial Router

Wireless Data Connectivity

Control Relay Qty	2	00 02H	Range: 0000H-0001H
Write Byte Qty	1	01H	Write 1 byte, since device only 2DO, use 4 binary can do it
Writing Data	1	03H	Send status data to control DO
16CRC Verify	2	9E 96H	CRC0 CRC1 low byte in front, high behind

Receiver Return Data Format:

Content	Bytes	Data (H: HEX)	Description
Device Address	1	01H	01H Device, according to the data Master send
Function Code	1	0FH	Write multi holding coil type
DO Register Address	1	00 00H	Range: 0000-0001, stands for DO1-DO2
Active	1	00 02H	Range:0001H-0002H, stands for already activated relays
16CRC Verify	2	D4 0AH	CRC0 CRC1 low byte in front, high behind

Example: Close device 2 DO at same time, then:

Server send: 01 0F 00 00 00 02 01 03 9E 96

01= Device address; 0F= Control multi relay; 00 00= Relay DO0 starting address; 00 02= Control 2 relays; 01= Send data qty; 03= Data sent converter to binary 0000 0011 from low to high stands for DO1-DO2 status, 0 stands for open relay, 1 stands for close relay:

DO2	DO1
1	1
Close	Close

9E 96 CRC verify.

Device answer: 01 0F 00 00 00 02 D4 0A

01= Device address; 0F= Control multi relay; 00 00= Relay DO0 starting address; 00 02= Activated 2 relays; D4 0A CRC verify.

6.1.2.5 Read Device AIN Status and DIN Pulse counter

Master Send Data Format:

Content	Bytes	Data (H: HEX)	Description
Device Address	1	01H	01H Device, Range: 1-247, according to setting address
Function Code	1	04H	Read input register, function code 04
Register Starting Address	2	00 00H	Every 2 16-bit address corresponds to 1 AI 32-bit register
Read Register Qty	2	00 0CH	A total of 12 16-bit addresses are read, each of the two 16-bit addresses is combined into a 32-bit address, a total of 6 32-bit addresses, that is, the number of read AI 4 and the DI pulse count 2



4G Wireless Industrial Router

Wireless Data Connectivity

16 CRC Verify	2	F00FH	CRC0 CRC1 low byte in front, high behind
---------------	---	-------	--

Receiver Return Data Format:

Content	Bytes	Data (H: HEX)	Description
Device Address	1	01H	01H device, consistent with download data
Function Code	1	04H	Read the hold coil
Return Bytes Qty	1	18H	Return data length
Returning Data	16	3B 98 4E 40 40 80 00 00 3C 89 15 BE 3B D7 51 8B 00 00 00 03 00 00 00 06H	Return AI data,32-bit float,ABCD
16 CRC Verify	2	22 80H	CRC0 CRC1 low byte in front, high behind

Example: Inquiry device 4 AIN and 2 DIN pulse data at same time, then:

Server send: 01 04 00 00 00 0C F0 0F

01= Device address; 04= read input register; 00 00= Starting address ; 00 0C= Serial reading 12 input register value; ,F0 0F= CRC verify.

Device return: 01 04 18 3B 98 4E 40 40 80 00 00 3C 89 15 BE 3B D7 51 8B 00 00 00 03 00 00 00 06 22 80

01= Device address; 04= read input register; 18= Return data bity ; 3B 98 4E 40 40 80 00 00 3C 89 15 BE 3B D7 51 8B 00 00 00 03 00 00 00 06=return data, detail as follows:

Analog input	AI4	AI3	AI2	AI1	DI1 pulse	DI2 pulse
Receiving Data (32-bit floating)	3B D7 51 8B	3C 89 15 BE	40 80 00 00	3B 98 4E 40	3B 98 4E 40	3B 98 4E 40
Real value	0.006571	0.016734	4	0.004648	3	6

22 80: CRC verify.

6.1.3 Read Mapping Address

6.1.3.1 Mapping Register Address

1) Boolean Slave Mapping Register Address, holding coil type (Function Code 01/02/05/15)

Modbus Register Address(Decimal)	PLC or configuration address (Decimal)	Data Name	Data Type	Description
64	00065 or 10065	Bool 64	Bool	Boolean type, slave mapping address, can map the slave input coil and holding coil state, 193 addresses in total.
65	00066 or 10066	Bool 65	Bool	
66	00067 or 10067	Bool 66	Bool	
...	Bool	
...	Bool	
256	00257 or 10257	Bool 256	Bool	



4G Wireless Industrial Router

Wireless Data Connectivity

2) 16 Bit Slave Register Assignment Table

Read and Write Holding Register (Function Code 03,04, 06, 16)				
Modbus Register Address(Decimal)	PLC or configuration address (Decimal)	Data name	Data Type	Description
20001	420002 or 320002	16 Bit data 20001	Sort AB, its data type according to slave mapping data type	According to configurator set mapping rules, this address will sort slave mapping data to AB, stock in this address, for cloud easy reading together, can mapping slave inputting and holding register.
20002	420003 or 320003	16 Bit data 20002	Same as above	Same as above
20003	420004 or 320004	16 Bit data 20003	Same as above	Same as above
.....	127 data similar as above	Same as above	Same as above
20127	420128 or 320128	16 Bit data 20127	Same as above	Same as above

3) 32 Bit Slave Register Assignment Table

Holding Register and input Register(Function Code 03,04, 06, 16)				
Modbus Register Address(Decimal)	PLC or configuration address (Decimal)	Data name	Data Type	Description
20128	420129 or 320129	32 Bit data 20128	Sort ABCD, its data type according to slave mapping data type	According to configurator set mapping rules, this address will sort slave mapping data to ABCD, stock in this address, for cloud easy reading together, can mapping slave inputting and holding register.
20130	420131 or 320131	32 Bit data 20130	Same as above	Same as above
20132	420133 or 320133	32 Bit data 20132	Same as above	Same as above
.....	64 data similar as above	Same as above	Same as above
20254	420255 or 320255	32 Bit data 20254	Same as above	Same as above



6.1.3.2 Read Boolean Mapping Address Data

Master Send Data Format:

Content	Bytes	Data	Description
Device ID	1	01H	01H Device, Range: 1-247, according to setting address
Function Code	1	01H	Read holding coil type, function code 01
Boolean Register Starting Address	2	00 40H	Range: 0040H-0100H, address refer to ["Slave Mapping Register Address"]
Read Register Qty	2	00 0AH	Range: 0001H-00C1H
16 CRC Verify	2	BD D9H	CRC0 CRC1 low byte in front, high behind

Receiver Return Data Format:

Content	Bytes	Data	Description
Device ID	1	01H	01H Device, Range: 1-247, according to setting address
Function Code	1	01H	Read holding coil type
Return Data Length	1	02H	Return data length
Returning Data	2	73 01H	
16 CRC Verify	2	5D 0CH	CRC0 CRC1 low byte in front, high behind

Example: Start from address 64, read 10 Boolean mapping data value, then:

Server send: 01 01 00 40 00 0A BD D9

01= Device ID; 01 = Read holding coil; 00 40 = Read Boolean data start from address 64; 00 0A = Serial to read 10 Boolean status; BD D9 CRC Verify.

Device answer: 01 01 02 73 01 5D 0C

01= Device ID; 01 = Read holding coil; 02= Return Data byte; 73 01= Return 10 Boolean status. High byte stands for low address data, low address stands for high address. According to Modbus protocol, fix 73 01H real value to be 01 73H, converter to Binary as below:

Register mapping address	Invalid	Invalid	Invalid	Invalid	Invalid	Invalid	73	72
Value	0	0	0	0	0	0	0	1
Register mapping address	71	70	69	68	67	66	65	64
Value	0	1	1	1	0	0	1	1

The address value higher than 10 digits will be seen as invalid.

5D 0C CRC Verify.

6.1.3.3 Modify Boolean Mapping Address Data

If control slave's relay status which connected to RS485, need to add slave in slave list of configurator. Write command 15 for mapping, when mapping address value modified, will write to RS485 matched slave address.

Master Send Data Format:

Content	Bytes	Data	Description
---------	-------	------	-------------



4G Wireless Industrial Router

Wireless Data Connectivity

		(H: HEX)	
Device Address	1	01H	01H Device, Range: 1-247, according to setting address
Function Code	1	05H	Write single holding coil, function code 05H
Boolean Mapping Register Address	2	00 40H	Range: 00 40H-0100FH, address refer to [" Mapping Register Address "]
Write value	2	FF 00H	This value: FF 00H or 00 00H, FF 00H stands for write 1; 00 00H stands for write 0
16 CRC Verify	2	8D EEH	CRC0 CRC1 low byte in front, high behind

Receiver Return Data Format:

Content	Bytes	Data (H: HEX)	Description
Device Address	1	01H	01H Device, according to the data Master send
Function Code	1	05H	Write single holding coil
Boolean Mapping Register Address	2	00 40H	Range: 00 40H-0100FH, address refer to [" Mapping Register Address "]
Write value	2	FF 00H	This value: FF 00H or 00 00H. FF 00H stands for write 1, 00 00H stands for write 0.
16 CRC Verify	2	8D EEH	CRC0 CRC1 low byte in front, high behind

Example: Modify Boolean mapping address 64 status, modify to 1, then:

Server send: 01 05 00 40 FF 00 8D EE

01= Device address; 05= Write boolean value; 00 40=The mapping address which need to revise; FF 00 = Write 1; 8D EE CRC Verify.

Device answer: 01 05 00 40 FF 00 8D EE

01= Device address; 05= Write boolean value; 00 40= The mapping address which need to write; FF 00= Write 1; 8D EE CRC Verify.

If need multiple modify, pls check function 15 of Modbus protocol.

6.1.3.4 Read Data Type Mapping Address Data

Master Send Data Format:

Content	Bytes	Data (H: HEX)	Description
Device Address	1	01H	01H Device, Range: 1-247, according to setting address
Function Code	1	03H	Read holding register, function code 03
Mapping Register Starting Address	2	4E 20H	One address can read 2 bytes. Mapping data type address range, refer to [" Slave Mapping Register Address "] at manual bottom.
Read Mapping Register Qty	2	00 0AH	Read input register qty.
16 CRC Verify	2	82 EFH	CRC0 CRC1 low byte in front, high behind

Receiver Return Data Format:



4G Wireless Industrial Router

Wireless Data Connectivity

Content	Bytes	Data (H: HEX)	Description
Device Address	1	01H	01H Device, according to the data Master send
Function Code	1	03H	Read holding register
Range Data Bytes	1	14H	One address can read 2 bytes
Returning Data	20	00 14 00 1E 00 28 00 32 00 4B 00 41 00 0A 00 25 00 14 00 2AH	Returning Data
16 CRC Verify	2	FB 34H	CRC0 CRC1 low byte in front, high behind

Example: Mapping address start from 20001, read 10 address data, then:

Server send: 01 03 4E 21 00 0A 82 EF

01= Device address; 03= Read holding register ; 4E 21=Mapping register starting address, current is Decimal data 20001; 00 0A = Read 10 register value; 82 EF=16 CRC Verify.

Device answer: 01 03 14 00 14 00 1E 00 28 00 32 00 4B 00 41 00 0A 00 25 00 14 00 2A FB 34

01= Device address; 03= Read holding register; 14= Returning 20 byte; 00 14 00 1E 00 28 00 32 00 4B 00 41 00 0A 00 25 00 14 00 2A = Returning data.

Register Mapping Address	20010	20009	20008	20007	20006	20005	20004	20003	20002	20001
Value	00 2A	00 14	00 25	00 0A	00 41	00 4B	00 32	00 28	00 1E	00 14

FB 34=16 CRC Verify.

6.1.3.5 Modify Data Type Mapping Address Data

If need to revise slave data which RS485 connected, need to add slave in slave list of configurator. Write command 03 for mapping, when mapping address value modified, will write to RS485 matched slave address. If address 20001 mapping slave data type is Signed Int, sort AB.

Master Send Data Format:

Content	Bytes	Data (H: HEX)	Description
Device Address	1	01H	01H Device, Range: 1-247, according to setting address
Function Code	1	06H	Write single holding register, function code 06
Mapping Register Address	2	4E 21H	Mapping data type address range, refer to [" Slave Mapping Register Address "]
Write Data	2	00 64H	Data writing value is Decimal data 100
16 CRC Verify	2	CF 03H	CRC0 CRC1 low byte in front, high behind

Receiver Return Data Format:

Content	Bytes	Data (H: HEX)	Description
Device Address	1	01H	01H Device, according to the data Master send
Function Code	1	06H	Write single holding register
Mapping Register	2	4E 21H	Mapping data type



4G Wireless Industrial Router

Wireless Data Connectivity

Address			
Write Data	2	00 64H	Write 100 successfully
16 CRC Verify	2	CF 03H	CRC0 CRC1 low byte in front, high behind

Example: If address 20001 mapping slave data type is Signed Int, sort AB, modify mapping address 20001 register to 100, then:

Server send: 01 06 4E 21 00 64 CF 03

01= Device address; 06= Modify single holding register value; 4E 20=Modify address 20001 register value; 00 64 = Write Decimal value 100; CF 03=16 CRC Verify.

Device answer: 01 06 4E 20 00 64 CF 03

01= Device address; 06= Modify single holding register value; 4E 20= R Modify address 20001 register value; 00 64= Modify to Decimal value 100, CE 03=16 CRC Verify.

If need to modify multiple data type mapping address, pls check function code 16 in Modbus protocol.

6.2 MQTT Protocol

MQTT is a client-server based message publish/subscribe transport protocol. The MQTT protocol is lightweight, simple, open, and easy to implement, and these features make it very versatile. In many cases, including restricted environments such as machine to machine (M2M) communication and the Internet of Things (IoT). It is widely used in satellite link communication sensors, occasionally dialed medical devices, smart homes, and some miniaturized devices. The MQTT protocol runs on TCP/IP or other network protocols, providing ordered, lossless, two-way connectivity.

6.2.1 MQTT Introduction

MQTT is a client-server based message publish/subscribe transport protocol. The MQTT protocol is lightweight, simple, open, and easy to implement, and these features make it very versatile. In many cases, including restricted environments such as machine to machine (M2M) communication and the Internet of Things (IoT). It is widely used in satellite link communication sensors, occasionally dialed medical devices, smart homes, and some miniaturized devices. The MQTT protocol runs on TCP/IP or other network protocols, providing ordered, lossless, two-way connectivity.

6.2.2 MQTT Principle

There are three identities in the MQTT protocol: Publisher (Publish), Broker (Server), Subscriber (Subscribe). Among them, the publisher and subscriber of the message are both clients, the message broker is the server, and the message publisher can be the subscriber at the same time.

Devices use MQTT communication through only two steps.

1.Devices publish the Topic through broker;

2. Users can create a account on broker to subscribe to the device to achieve monitoring

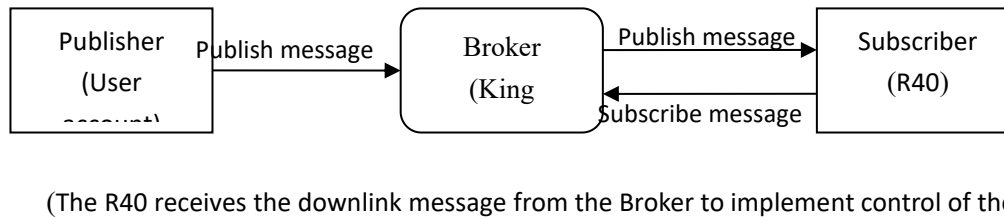
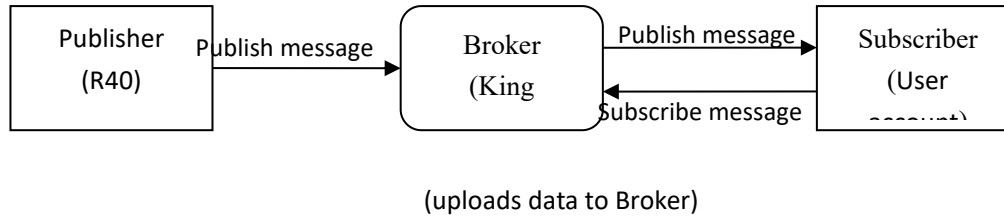

6.2.3 Device Communication Application

Client configuration

1. Connect Platform: King Pigeon 2.0 or other cloud platform to enter the corresponding IP and port.
2. Connection protocol: MQTT.
3. MQTT client ID: the unique identification of the device, which can be a serial number, device ID, or IMEI code; (King Pigeon 2.0 device ID defaults is the serial number).
4. MQTT account: the account where the device publishes the theme on the proxy server (King Pigeon 2.0 defaults is MQTT).
5. MQTT password: the device's account password for publishing the theme on the proxy server (King Pigeon 2.0 defaults is MQTTPW).
6. Publish topic: refers to the topic of the device publishing uplink data to the platform, King Pigeon Cloud 2.0 is the serial number.
7. Subscription topic: refers to the topic that the device subscribes to when receiving downlink data, King Pigeon Cloud 2.0 is the cloud platform serial number/+.
8. Release cycle (seconds): MQTT data release interval, in seconds. The Golden Pigeon Cloud 2.0 cycle needs to be set to 10 seconds or more. If it is less than 10 seconds, the platform will disable the device.
9. Publisher QOS: The service quality level guarantee for application message distribution, 0-at most once, 1-at least once, 2-only once, you can choose according to your needs.
10. Encryption: You can use encryption to connect to the server according to your needs, and you can choose not to encrypt when you connect to King Pigeon Cloud 2.0.
11. Enable data retransmission: Check enable, after enabling, when reconnecting to the cloud platform, the data during the offline period will be retransmitted.
12. Data packing: After checking, send multiple data in one message, when unchecked, one message corresponds to one I/O data point.

After the configuration is complete, the client will initiate a connection to the server:

CONNECT: The client sends a CONNECT connection message request to the server;

CONNACK: The server responds with a CONNACK confirmation connection message, indicating that the connection is successful;

After the client establishes a connection, it is a long connection, and the client can publish or subscribe to the message on the server;

For example the device and the client's mobile phone as the client:

After the device publishes the topic on the proxy server, customers can view the data through subscription.

That is, the device is the publisher and the customer's mobile phone is the subscriber.



Users can also publish topics through the MQTT server to control the device. That is, the user is the publisher and the device is the subscriber.

6.2.4 Publish MQTT Format

If data packing is ticked during configuration, multiple I/O data points will be sent in one message (when there are many data points, multiple messages will be sent separately, and each message contains multiple data points), if not checked, one The message only corresponds to one I/O data point, the two publishing formats are slightly different, so you need to pay attention

(1)Following is the device communication data format(Data packing):

Publish Topic Name: serial numbers // Corresponding configured topic options

```
{
"sensorDatas":
[
  {
    // switch type,
    "switcher":"1", // Data type and value
    "flag":"DI1" //Read and write Flag
  },
  {
    // Slave switch type
    "switcher":"0", // Data type and value
    "flag":"REG64" //Read and write Flag
  },
  {
    //value
    "value":"10.00",
    "flag":"AI1"
  },
  {
    //Slave value
    "value":"217.5",
    "flag":"REG2001"
  },
  {
    //Positioning
    "lng":"116.3", // longitude data
    "lat":"39.9", // latitude data
    "spd":"0.0", // speed data
    "dir":"0.0", // direction data
    "flag":"GPS"
  }
],
"time":"1602324850" //Time , data release timestamp UTC format
  "retransmit":"enable"
  //Retransmission flag, indicating historical data (retransmission historical data only has this flag,
  real-time data does not have this flag)
}
```



4G Wireless Industrial Router

Wireless Data Connectivity

Note:

Each I/O point must contain three types of information when the device publish message: add Time, data type and value, read and write flag;

// Data type and value: according to the type is divided into the following:

1. The numeric character is "value" followed by: "data value".
2. The switch character is "switcher" followed by: "0"or"1" (0 is close,1 is open).
- 3.Positioning data :

The GPS longitude character is "lng" and the value is: "data value".

The GPS latitude character is "lat" and the value is: "data value".

The GPS speed character is "spd" and the value is: "data value".

The GPS direction character is "dir" and the value is: "data value".

Read and write Flag:

Each I/O port has a fixed flag when the device publish a message, The specific flags are as follows:

Device own I/O Port

Data name	Flag	Data type	Description
Digital output	DO1,DO2	Switcher	0 is open,1 is close
Digital input	DI1,DI2	Switcher	0 is open,1 is close
Analog input	AI1,AIN2,AIN3,AIN4	Value	The actual value = original value
Network failure	DI3~DI22	Switcher	0 is offline,1 is online
Pulse count	COUNT1,COUNT2	Value	

Extend I/O Port

Data name	Flag	Data type	Description
Boolean	REG64~256	Switcher	Defined according to slave data
16 Bit	REG20000~20127	Value	Defined according to slave data
32 Bit	REG20128~20254	Value	Defined according to slave data

Note:

//Time flag: the character is "time", followed by "specific reporting timestamp"

//Retransmission flag: the character is "retransmit", followed by "enable"

The data collected during the network offline period will be temporarily stored in the device, and will be republished when the network is restored. It is identified by the "retransmit" field to indicate historical data. (Need to check the enable data transmission on the configuration interface)

(2) The payload data format in the device release message (data unpacking)

```
Publish Topic: serial numbers
{
  "switcher": "0",
  "flag": "DI1",
  "time": "1602324850"
}
```

Note: When the data is unpacking, there is a little difference except for the format. The others are exactly the same. This is an example of DI1. For other data types, please refer to the above description.

6.2.5 Device Subscribe MQTT Format

The payload data format in the device subscription message



4G Wireless Industrial Router

Wireless Data Connectivity

Subscription format:serial number /+ (subscription topic needs to add the wildcard "/" after the serial number)

```
{
  "sensorDatas":
  [
    {
      "sensorId": 211267,           // cloud platform sensor ID
      "switcher":1,              // switch type data, 0 is off, 1 is closed
      "flag":"DO1"              //read write flag
    }
  ],
  "down":"down"                // platform downlink message
}
```

Note:

The data sent by the device control must contain three types of information: sensor ID, data type,flag, and downlink message packet.

//Sensor ID: The character is "sensorsID", and the ID is automatically generated according to the platform definition.

// Data type and value: according to the type is divided into the following:

1. The switch character is " switcher " followed by: "0"or "1",0 is open,1 is close.
2. The numeric character is " value " followed by: "data value"

//Read write flag: the character is "flag" followed by "flag"

// "down" confirmation data sent to subscribers by the platform.

7. SMS Command List

This device supports remote query and control operations through SMS commands. The following are the precautions:

1. The default password is 1234, you can edit the SMS command to modify the password;
2. The "password" in the SMS command refers to the device password, such as 1234, just enter the password directly;
3. The "+" sign in the SMS command is not used as the content of the SMS, please do not add any spaces or other characters;
4. The SMS command must be CAPITAL LETTERS, such as "PWD" instead of "pwd";
5. If the password is correct but the command is incorrect, the device will return: SMS Format Error, Please check Caps Lock in Command! So please check the Command, or add the country code before the telephone number or check the input is in ENGLISH INPUT METHOD and CAPS LOCK. If password incorrect then will not any response SMS.
6. If the password is entered incorrectly, no information will be returned;
7. Once the Unit received the SMS Command, will return SMS to confirmation, if no SMS return, please check your command or resend again.

1) Modify Password, 4 digits, default is 1234



4G Wireless Industrial Router

Wireless Data Connectivity

SMS Command	Return SMS Content
Old Password + P + New Password	Password reset complete

2) Inquiry Current Status SMS Command

SMS Command	Return SMS Content
password+EE	Model:xxx Version:xxx IMEI:xxx GSM Signal Value:xxx

3) Inquiry DIN Status

SMS Command		Return SMS Content
Inquiry Status	password+DINE	DIN1: Open/Close DIN2: Open/Close -----

4) Set Digital Output

SMS Command		Return SMS Content
Switch ON DO1(Close)	password+DOC1	DO1: ON
Switch OFF DO1(Open)	password+DO1	DO1: OFF
Switch ON DO2(Close)	password+DOC2	DO2: ON
Switch OFF DO2(Open)	password+DO2	DO2: OFF
Inquiry DO Current Status	password+DOE	DO1: ON/OFF DO2:ON/OFF

5) Inquiry AIN Status

SMS Command		Return SMS Content
Inquiry Status	password+AINE	AIN1:xxx AIN2: xxx AIN3:xxx AIN4: xxx

6) Digital Pulse Counter

SMS Command		Return SMS Content
Inquiry Pulse Counter Value	password+PR	DI1 counter value:xxx DI2 counter value:xxx
Clear DI1 Pulse Counter	password+DI1CLR	DI1 clear successfully
Clear DI2 Pulse Counter	password+DI2CLR	DI2 clear successfully

8. Warranty

- 1) This device is warranted to be free of defects in material and workmanship for one year.
- 2) This warranty does not extend to any defect, malfunction or failure caused by abuse or misuse by the Operating Instructions. In no event shall the manufacturer be liable for any router altered by purchasers.

The End!

Any questions please help to contact us feel free.

[Http://www.IOT-SOLUTION.com](http://www.IOT-SOLUTION.com)



4G Wireless Industrial Router

Wireless Data Connectivity
